

Sustainability



Top Commitment

Kazuo Kawamura
 President and
 Representative Director



Meiji Group Sustainability 2026 Vision

As Food and Health professionals, we contribute to addressing social issues through our business activities, and to realizing a sustainable society for people to live healthy, peaceful lives.

Meiji Group Sustainability

- > Top Commitment
- > Sustainability Management
- > Sustainability Video

Healthier Lives

- > Health and Nutrition
- > Quality and Safety

Caring for the Earth

- > Environmental Management
- > Climate Change
- > Circular Economy
- > Water
- > Biodiversity

A Richer Society

- > Human Resources
- > Society

Shared Themes

- > Sustainable Procurement



[▶ Governance](#)

[▶ Policies](#)

[▶ Download Report](#)

[▶ Collaboration with UN Agencies and Relevant Organizations](#)

[▶ ESG Data](#)

[▶ Standard Table](#)

Sustainability Announcements

- Apr 1, 2020 2018-2019 Progress Report for Tackling Deforestation in Ghana
- Feb 14, 2020 We received a high grade of A- in CDP climate change
- Jan 7, 2020 We updated Standard Table
- Dec 19, 2019 【Presentation】 Sustainability Meeting ~ Meiji Group's Approach to Sustainability ~
- Dec 10, 2019 Endorsing the TCFD, Joining the TCFD Consortium

[▶ More](#)



Meiji Group Sustainability



▶ Top Commitment



▶ Sustainability Management



▶ Sustainability Video

Top Commitment



The Meiji Group expands the world of Tastiness, Enjoyment, Health, and Reassurance across a wide range of products for every customer, from infants to senior citizens. We provide value in Food and Health that is always moving one step ahead, and we continue to grow in Japan and throughout the world, leveraging our strengths in technology and expertise developed over 100 years of experience.

At the same time, the world has high expectations for the Sustainable Development Goals of the United Nations in the face of global warming, population growth and food shortages, plastics polluting our oceans, and other grave developments.

To respond to the expectations of society, the Meiji Group created the Meiji Group sustainability 2026 Vision. We have designated *Sustainable Procurement* as a common theme together with *Healthier Lives*, *Caring for the Earth*, and *a Richer Society*, defining materiality and setting key performance indicators as part of moving toward this vision to solve societal issues through our businesses.

Our core business is to help people live *Healthier Lives*. To contribute to healthier diets and respond to an ultra-aging society, we identify the health needs of our diversifying customer base. Then, we use our strengths developed through foods and pharmaceuticals, as well as our advanced expertise in nutrition and medicine, to offer new value.

In *Caring for the Earth*, we share and address the issues in common with the entire planet. Here, we are adopting renewable energy as part of our decarbonization policy. We are also working to reduce food loss by half and recycle plastic resources.

A Richer Society is a society that creates connections among people. We respect human rights and diversity, while fostering the type of personnel necessary for creating innovation. At the same time, we strive to create a positive workplace for all that encourages health management and offers work-style reforms.

Finally, under our common theme of *Sustainable Procurement*, we are moving forward steadily with plans for using certified palm oil as a substitute ingredient, while coordinating with organizations involved in procurement activities that reflect a respect for human rights and the environment.

To communicate our sustainability vision and corporate stance, we have added policies related to taxes, anti-corruption, and other governance matters in addition to the policies on human rights, occupational health and safety, environment, and procurement already in place. We will continue to address these and other initiatives as a group.

The Meiji Group is serious about corporate growth, as well as addressing the social issues surrounding our businesses. As we contribute solutions to these issues, we strive to help create a sustainable society.

March 2019

Kazuo Kawamura
President and Representative Director
Meiji Holdings Co., Ltd.

Sustainability Management

The basis of “the Meiji Group's Approach to sustainability” is to fulfill sustainability by putting the Group Philosophy into practice on a day-to-day basis in mainstay businesses and by remaining a corporate group society needs. Each Meiji Group employee will advance activities based on the Corporate Behavior Charter to meet stakeholders' expectations and continue fulfilling social responsibilities.

Meiji Group 2026 Vision

Our promise and commitment for the 2026 Vision

We will combine the strengths, the Meiji Group has cultivated over the past 100 years, with the latest technology and new findings. Thus we create innovative ways to meet our customers' needs with food and health and grow in Japan and around the world sustainably.

Approach

Key Strategies

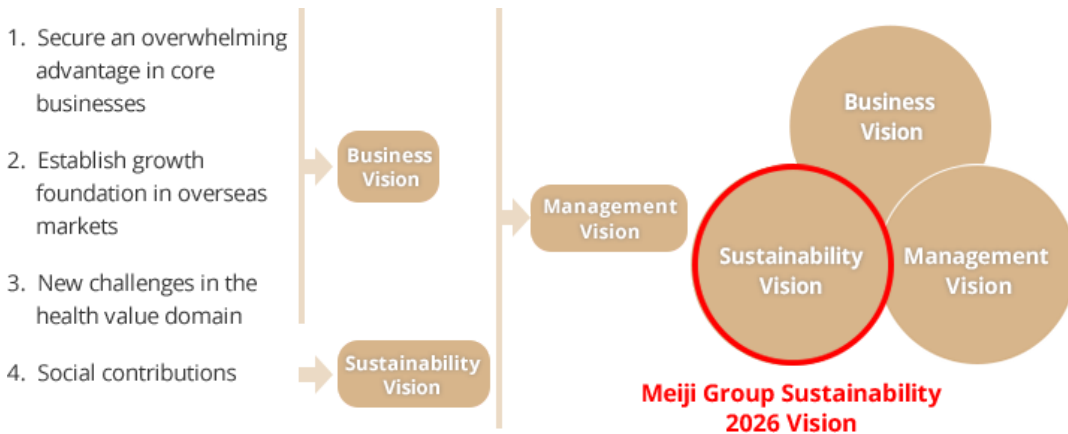

Meiji Group Sustainability 2026 Vision

As Food and Health professionals, we contribute to addressing social issues through our business activities, and to realizing a sustainable society for people to live healthy, peaceful lives.

The Meiji Group has created the Meiji Group Sustainability 2026 Vision. This was designed to embody “Social contributions”, which is a key strategy in the Meiji Group 2026 Vision. The sustainability vision identifies activities that the Meiji Group should embrace over the long term. We have set KPIs so that the Group Sustainability Committee can monitor our progress and disclose information.

Creating our Vision

STEP 1

Identify issues and select activities



Select activities tailored for the Meiji Group considering business initiatives, community requests and sustainable development goals (SDGs).

STEP 2

Identify materiality and set the KPIs



Set the KPIs. Confer with experts outside of the company regarding the selected activities, identify materiality (material issues).

STEP 3

Obtain approval from management

Sustainability secretariat and the Group Sustainability Committee discusses, and the Board of Directors makes a decision.

Progress of Sustainability 2026 Vision

2017

- Began discussions to establish vision



2018

- Established vision
- Identify materiality
- Revised how the vision's activities in each area are related to the SDGs



2019

- Joined UN Global Compact
- Discussions with outside experts
Mr. Peter David Pedersen

Outline of Vision

The Meiji Group Sustainability 2026 Vision is broken down into three themes: "Healthier Lives", "Caring for the Earth" and "A Richer Society". We established specific areas of activities under each theme. Based on this framework, shown in the figure, we promote sustainability activities that are developed in the Meiji way to fulfill our corporate responsibilities.

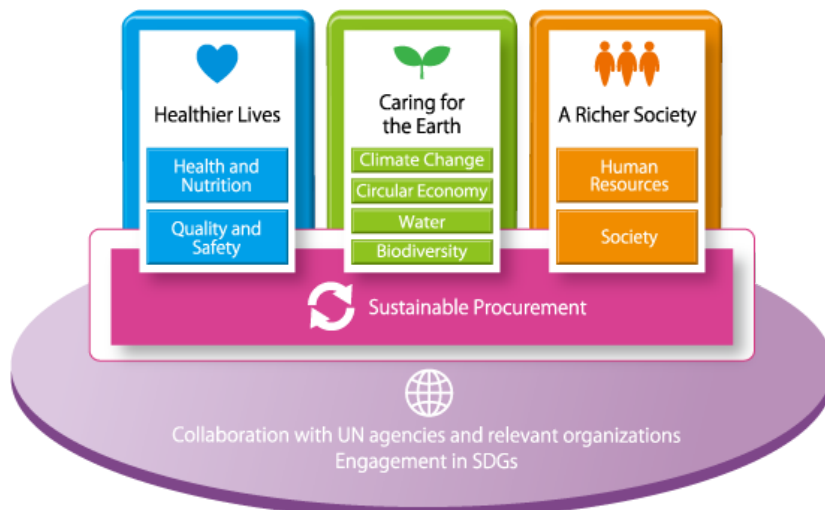

Progress on Materiality

After conferring with experts outside of the company, we identified materiality and set KPIs. As we continue to promote sustainability activities to achieve our KPIs, we shall report on our progress each year.

Red font: Identify materiality issues

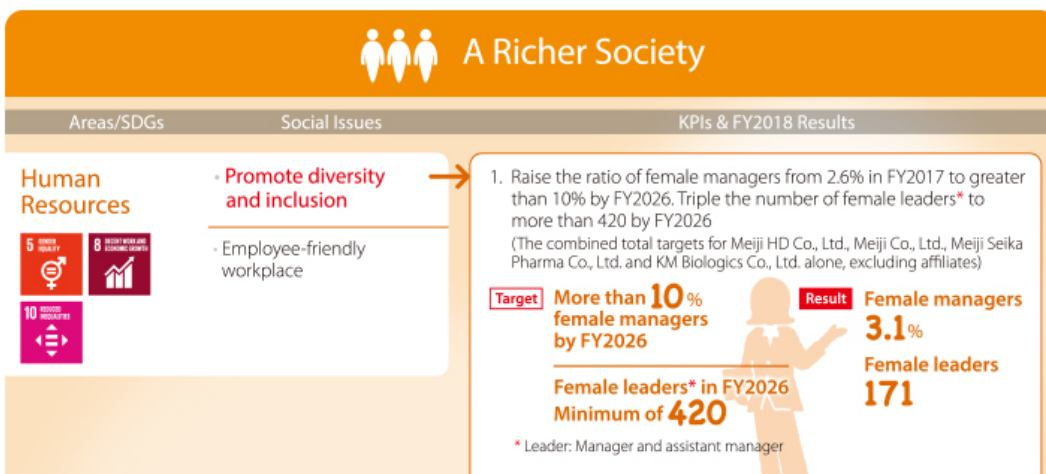
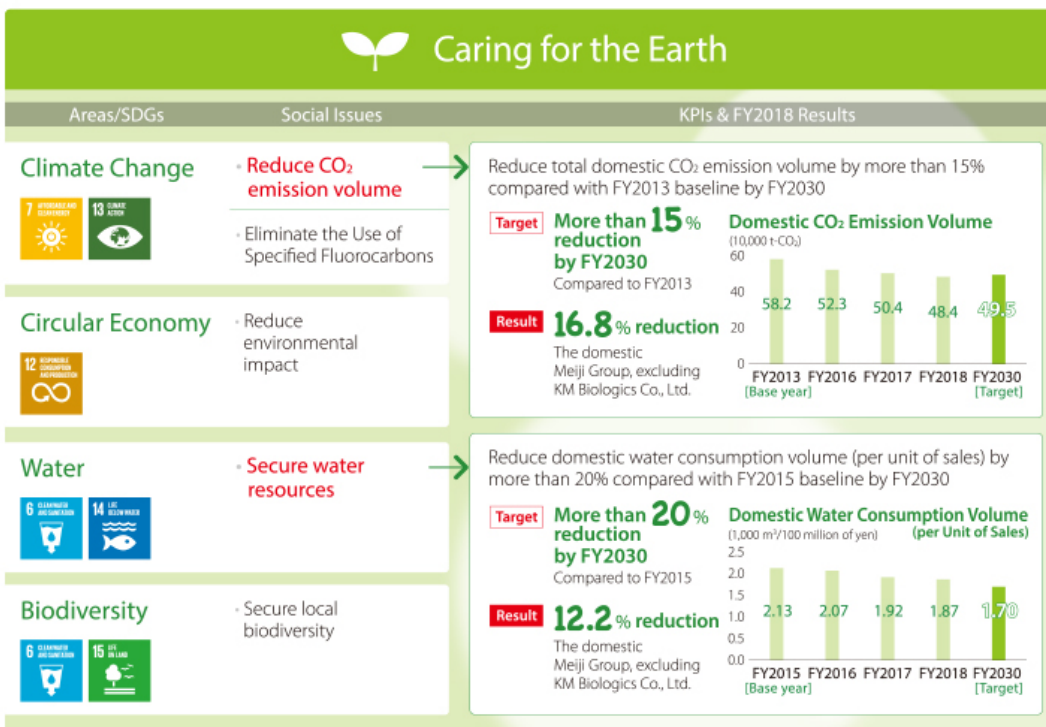
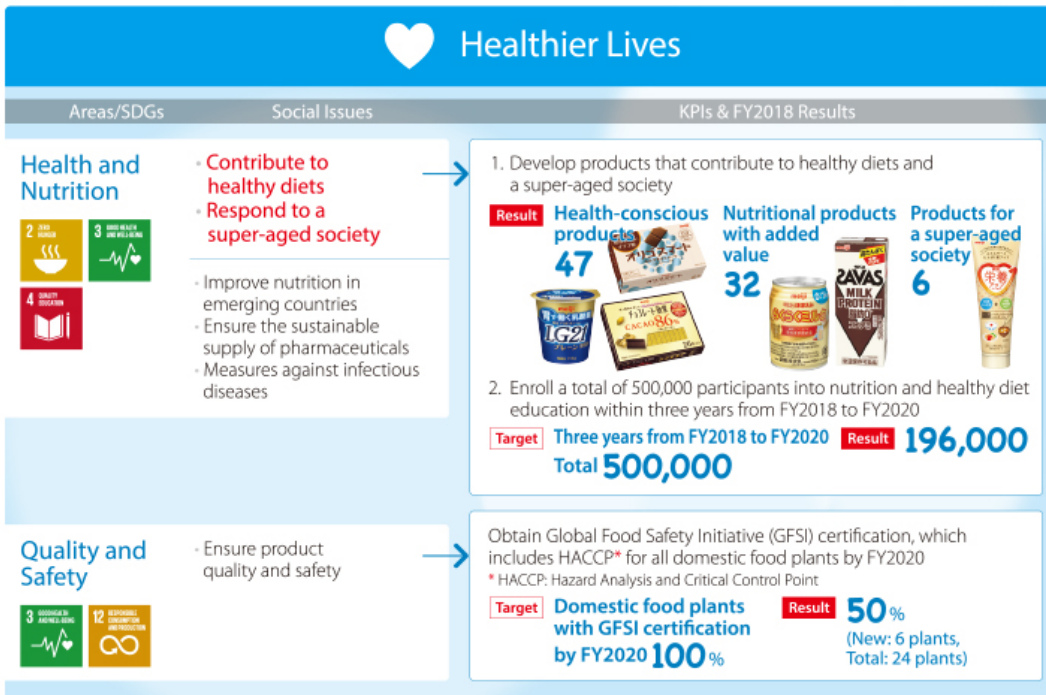

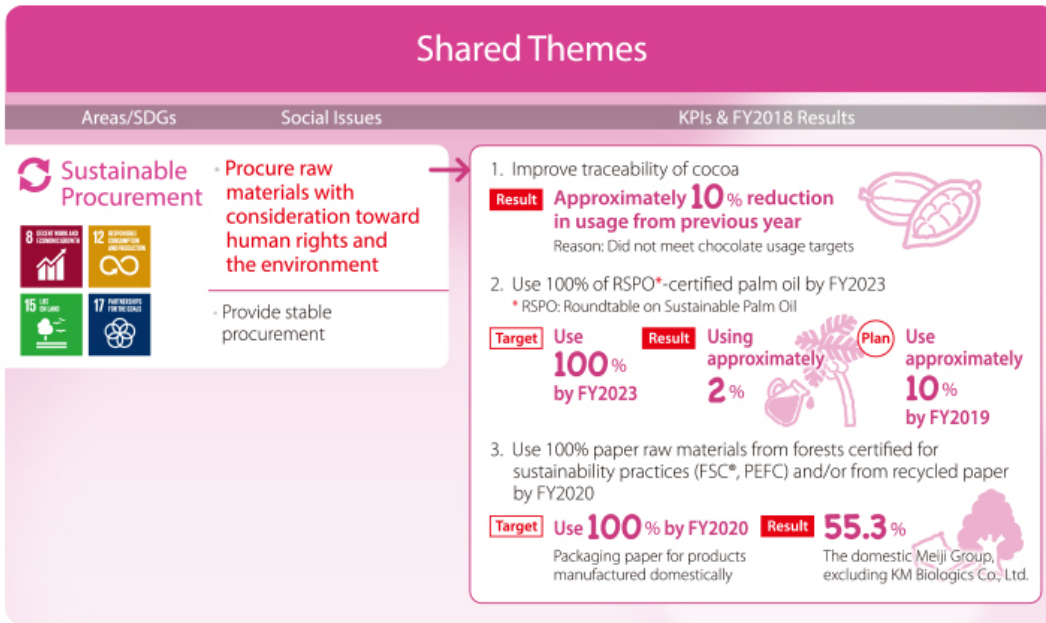
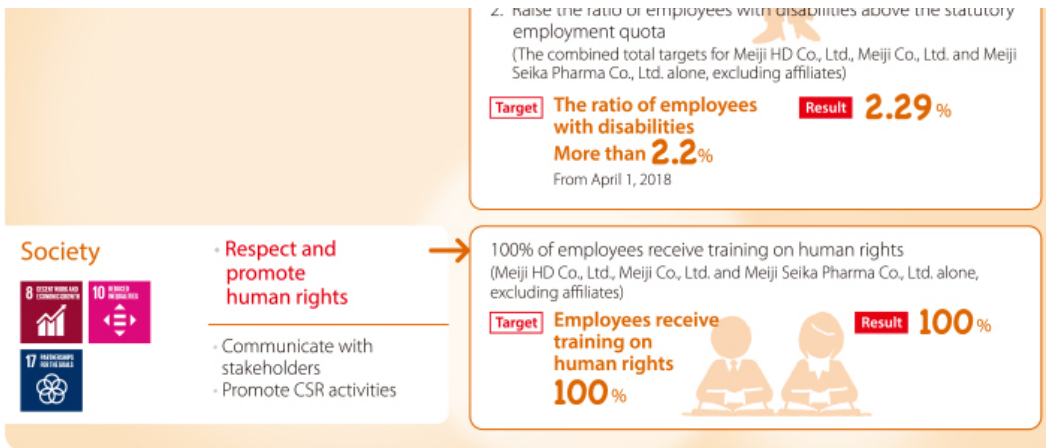

Feedback from Experts

In April 2019, Mr. Peter David Pedersen and Mr. Kawamura from Meiji Holdings Co., Ltd. discussed the Group's sustainability. Their dialogue covered a frank and lively exchange about a number of topics, including challenges the Group should prepare for after the Meiji Group sustainability 2026 Vision as well as sustainability activities unique to the Meiji Group. Use the link below to see the details of this discussion.



▲ The left side of the picture
Mr. Peter David Pedersen
Co-founder, NELIS
Director, TAEL
Co-founder, E-Square Inc.

What to Expect from the Meiji Group

The global population is expected to balloon to ten billion people by 2050, with 3 billion expected to live in slums and 52% of the population facing water stress or water scarcity. Social problems in the future can be viewed as a potential business chance so to speak. Therefore, it is important to weigh social issues appropriately and change them to business opportunities.

I believe, the Meiji Group can be classified as one of those companies that is essential to daily life. The Group must define the social issues that people face. It is my hope that the Group will bring employees together and successfully actualize innovation, solve problems as well as ensure growth globally.

In the age of SDGs, I think that it is well-timed that the Group set up the new sustainability 2026 Vision focusing on addressing social issues. I expect that the Group will continue to disclose information as the Group achieves success through its business.



Mr. Hidemi Tomita
Director, Lloyd's Register Japan
K.K.

▶ Sustainability Video (Meiji Group 2026 Vision)

Group Sustainability System

Approach

We have established the Group Sustainability Committee, with the President and Representative Director of Meiji Holdings Co., Ltd. at its helm, and will continue to engage in activities following this committee's direction. This committee meets twice annually. It monitors the progress of activities to achieve KPIs in the Meiji Group Sustainability 2026 Vision and also establishes sustainability policies. There is a sustainability Secretariat that meets monthly and is made up of the Sustainability representatives from Meiji Holdings Co., Ltd. and the operating companies. We share information to address issues, such as climate change and sustainable procurement, while staying on target with the SDGs. The progress of these Group Sustainability activities is reported twice annually at the Board meetings.



The Group Sustainability
Committee



Sustainability Promotion

Approach

Holding Workshops with Experts

The Group Sustainability Committee holds workshops with outside

professionals.

- July 2017: Mr. Hiroshi Tomita, the manager of Cre-en Inc., Sustainable Development Goals towards business
- July 2018: Mr. Tsuneo Oba, executive director of Global Compact Network Japan, Global Compact
- September 2019: Mr. Keisuke Takegahara, Deputy Chief Research Officer of Development Bank of Japan Inc., TCFD



Mr. Hiroshi Tomita's seminar

Informing Employees

The Meiji Group strives to keep employees informed about our sustainability system and activities. Each edition of our internal company magazines includes important sustainability information for domestic and overseas employees, such as recent sustainability activity news, special features on relevant topics, and policies. We have published internal company magazine "Meiji Journal" in English and Chinese biannually.



Our internal company magazine for domestic employees



Our internal company magazine "Meiji Journal" for overseas employees

Editorial Policy

Starting from August 2018, Meiji Group issues the Integrated Report and replace the Annual Report that has been issued up until now. This Sustainability web site complements the Integrated Report, introducing various activities contributing to the sustainability of the world.

Scope and Boundary of Reporting

Organizational Scope

This report covers the activities of the Meiji Group, comprising, unless otherwise noted, Meiji Holdings Co., Ltd., Meiji Co., Ltd., Meiji Seika Pharma Co., Ltd., and KM Biologics Co., Ltd., and these Group companies.

Period Covered

Fiscal Year End March 2019 (April 1, 2018-March 31, 2019)

Some qualitative information includes performance of FYE March 2020.

Guidelines Referenced

- GRI Sustainability Reporting Standards in 2016
- SASB
- Environment Reporting Guidelines (2018) by the Ministry of the Environment of Japan
- ISO26000

Issuance Period

Issued on: October 31, 2019

Next scheduled for issue in October 2020

■ For Further Information, please Contact

Meiji Holdings Co., Ltd.
Sustainable Management Department
2-4-16, Kyobashi, Chuo-ku, Tokyo 104-0031, Japan

Sustainability Video

Meiji Group Sustainability 2026 Vision



Meiji Cocoa Support

Meiji Cocoa Support helps us to source cocoa sustainably.



Healthier Lives

SDGs



We contribute to healthy minds and bodies through our business activities.

Health and Nutrition



Social Issue

Contribute to Healthy Diets

- › Develop Products That Contribute to Healthy Diets
- › Promote Healthy Diets and a Healthy Food Culture

Respond to a Super-Aged Society

- › Develop Products That Contribute to a Super-Aged Society
- › Conduct Educational Activities Aimed at Preventing Malnutrition

Improve Nutrition in Emerging Countries

- › Communicate Information on Nutrition Improvement in Emerging Countries

Ensure the Sustainable Supply of Pharmaceuticals

- › Ensure the Sustainable Supply of Drugs for Infectious Diseases, Drugs for Central Nervous System Disorders, Generic Drugs, and Vaccines

Measures Against Infectious Diseases

- › Appropriate Use of Antibiotics

Quality and Safety



■ Social Issue

🔴 Ensure Product Quality and Safety

- › Safety System Initiatives for Trusted Quality, Brand Recognition
- › Quality Management Based on Reliability Assurance Systems
- › Extensive Disclosures on Quality and Safety
- › Ethical Considerations in R&D

Health and Nutrition

SDGs



Social Issues

- ✔ Contribute to Healthy Diets ✔ Respond to a Super-Aged Society
- ✔ Improve Nutrition in Emerging Countries
- ✔ Ensure the Sustainable Supply of Pharmaceuticals
- ✔ Measures Against Infectious Diseases

KPI Develop products that contribute to healthy diets

FYE 3/2019

- ✔ Health-Conscious Products : 47 items
- ✔ Value-Added Nutrition Products : 32 items

KPI Enroll a total of 500,000 people into nutrition and healthy diet education within three years from FYE March 2019 to FYE March 2021

FYE 3/2019 ✔ 196,000 people

Contribute to Healthy Diets

Develop Products That Contribute to Healthy Diets

Consumers are going through lifestyle changes and diversifying health and nutritional needs. In response, we will leverage the strengths of our Food and Pharmaceuticals businesses and make use of our advanced expertise in the nutrition and pharmaceutical fields to offer new health value-added products.

Approach

Product Development by Utilizing Healthy *Lactobacillus* and Cocoa Ingredients

We will develop new probiotics, focusing on *lactobacillus*, and expand our lineup of high cocoa-content chocolate products that offer healthy cocoa polyphenols.



Link

➤ Research Library in Food Segment

Product Development by Utilizing New Healthy Ingredients

We will discover original ingredients and develop new products that support healthy lifestyles through exercise and physical activity.

Develop Health-Conscious Products

We will develop new products using healthy *lactobacillus*, cocoa polyphenols, and other healthy ingredients. We will develop new products that contain healthy ingredients to support healthy lifestyles.

Moreover, we will discover and supply products featuring reduced sugar, fat, calories, etc., to support the healthy needs of consumers.

■ Examples of Health-Conscious Products

- General products
 - Meiji Probio Yogurt LG21
 - Meiji Probio Yogurt R-1
 - Meiji Bulgaria Yogurt LB81 Plain
 - Chocolate Kouka Cocoa 86%
- Products with Reduced Sugar, Fat, Calories, Etc.
 - Meiji Oishii Gyunyu drinking milk (Low Fat)
 - Meiji Bulgaria Yogurt LB81 (Low Sugar, Zero Fat)
 - Meiji Probio Yogurt R-1 (Low Fat, Zero Fat, Low Sugar/Low Calorie)
 - Meiji Probio Yogurt LG21 (Low Sugar/Low Calorie)
 - Offstyle (Zero Cholesterol, Low Trans Fats)
 - Meiji Corn Soft margarine (Low Trans Fats)
 - Meiji Butter in Tube 1/3 Cholesterol (one-third the cholesterol of butter)



Evidence

■ Total Sales of Health-Conscious Products (Millions of yen)

FYE March 2015	174,049
FYE March 2016	200,193
FYE March 2017	222,288
FYE March 2018	221,914

Our FYE March 2019 Progress

Develop Products That Contribute to Healthy Diets : 47 items

Meiji Probio Yogurt LG21 Plain

Chocolate Kouka 86%

Oligosmart Milk chocolate



Develop Value-Added Nutrition Products

Changes in lifestyles mean new and varied eating patterns. We intend to leverage Meiji's nutrition design technology to develop total products (including volume, format, packaging, etc.) for the infant nutrition, sports nutrition, and medical nutrition fields.



Meiji Hohoemi
Cube 432g (27g x
16 packs)(infant
formula)



(SAVAS) MILK
PROTEIN Fat 0



SAVAS Whey
Protein 100 refill



SUPER VAAM
(sports nutrition)



Meiji Mei
Balance cup
(enteral formula)

Our FYE March 2019 Progress

Develop Value-Added Nutrition Products : 32 items

(SAVAS) MILK PROTEIN Fat 0 Cocoa flavor 200ml

Meiji Hohoemi Rakuraku Milk Liquid infant formula



Contributing to Healthy Growth with Our Infant Formula Featuring More Added Value

Since first launching in Japan a vitamin B1 fortified infant formula in 1923, the Meiji Group has been committed to the infant and toddler nutrition business to promote their healthy growth. We are currently supporting health in babies and toddlers by focusing on Meiji Hohoemi, which can be used as a breast milk replacement for infants, and on Meiji Step, which helps provide suitable nutrition for toddlers up to age 3. In addition, we developed the world's first infant formula in cube form to help in the child rearing process. It is designed for anyone to prepare the baby formula easily even for late night feedings, so that everyone in the family can participate in child rearing. In March 2019, we also launched a formula in liquid form that can be stored and fed at room temperature and offers a long shelf life. This is not only convenient when feeding outside of the home but gives mothers peace of mind as an emergency supply in the event of a disaster or emergency situation.

Link

- SAVAS (Whey Protein)
- VAAM (Vespa Amino Acid Mixture)

Promote Healthy Diets and a Healthy Food Culture

We offer products that support, and promote the awareness of, healthy diets and food culture to support the healthy lifestyles of our customers.

Approach

Expanding Nutrition and Healthy Diet Education Activities

Our education activities focus on three areas : Value and enjoyment of food, nutritional balance, and food-related safety and reassurance. We create opportunities for our customers to learn about and enjoy food, as well as to better understand the nutritional value and health benefits of different foods.

Since FYE March/2007, our nutrition and healthy diet education staff in five regions throughout

Japan have visited local elementary and junior high schools to provide on-site classes. We also engage in community-based food and nutrition seminars for adults. We amplified these activities in FYE March/2018 by holding other classes (exercise, food, and nutrition classes; gargle and hand-washing classes; fun milk classes; and chocolate and cocoa classes). We also sponsored an Olympic and Paralympic Games education program during FYE March/2018. Through experiences and lectures, participants learned the importance of sports and how physical training for sports contributes to improved health over the course of our entire lives.

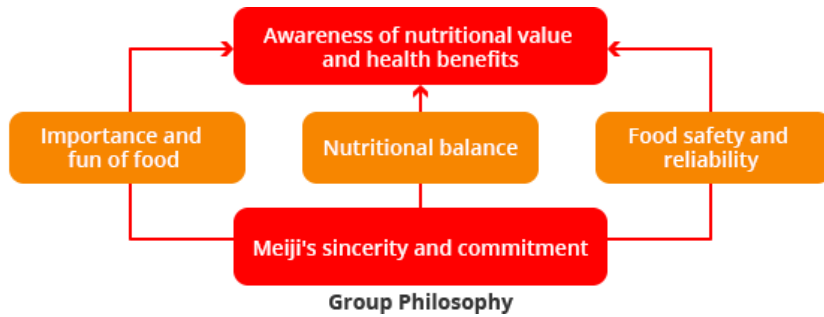

Evidence

Nutrition and healthy diet education activities : FYE March 2019

Domestic : 196,000 participants

Overseas : 3,759 participants



Chocolate and cocoa classes



Fun milk classes



Nutrition education in China

Plant Tours

Meiji Co., Ltd. plants include visitor centers that offer educational plant tours. Visitors can observe production processes firsthand, while learning about our commitment to food safety and reliability. These visitor centers also conduct fun and interactive classes. During FYE March/2019, more than 200,000 people visited one of our seven domestic food plants.

Three overseas plants (Meiji Ice Cream (Guang Zhou) Co., Ltd. (China), Meiji Dairies (Suzhou) Co., Ltd. (China), and Meiji Seika Food Industry (Shanghai) Co., Ltd. (China)) have been certified as centers for science and technology information, serving as proper models for the spread of science and technology information. More than 10,000 people visit one of these three plants annually.

Results

Plant tours : FYE March 2019

Domestic : 212,000 participants

Overseas : 11,145 participants

Meiji Ice Cream (Guang Zhou) Co., Ltd. : 6,006 participants

Meiji Seika Food Industry (Shanghai) Co., Ltd. : 3,069 participants

Meiji Dairies (Suzhou) Co., Ltd. : 2,070 participants



Large display Camembert Cheese mold

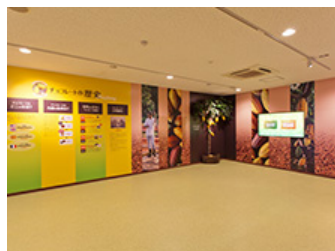

We can learn a production of chocolate process



Centers for science and technology information in Meiji Seika Food

Supporting Nutrition Through Sports

We provide a foundation for using sports to support healthy development, to build strong bodies, and to develop strong minds through food and nutrition. At nutrition seminars, we disseminate information on sports nutrition, including information to promote an understanding of preferable food choices and the proper use of supplements. We partner with associations and federations to provide nutritional support toward developing future top athletes. Through sports nutrition, we will continue to support the next generation of promising, talented, and versatile young athletes and their coaches.

Results

Sports Nutrition seminar : FYE March 2019

Domestic : 72,000 participants

* Sports Nutrition Seminar : Seminars offering information gained through nutrition support provided to junior athletes, student athletes, and runners.



Sports Nutrition seminar at JFA Youth & Development Program (JYD)

Link

- SAVAS (Whey Protein)
- VAAM (Vespa Amino Acid Mixture)

Communicating Information About Milk, *Lactobacillus*, and Cocoa

We publish and present the results of research on milk, *Lactobacillus*, and cocoa (raw ingredients in our products) in white papers and at conferences. We explain healthy effects of milk, *Lactobacillus*, and cocoa to our customers through nutrition and healthy diet education and plant tours. We will continue to pursue our mission of educating the world about health and nutrition.

Link

- Innovations in Food Segment
- Research Library in Food Segment

Home Delivery Service

We provide milk product home delivery services straight to the consumer through our distributors. This service is very popular with consumers throughout Japan. The mission of our home delivery service is to be near the consumer, contributing every day to their health. Our home delivery service reaches 2.6 million families, growing through improved distribution and outreach to local dairy distributors.

Our distributor network includes distributors who face losing their business due to owner age or lack of a successor. Realizing the need to help businesses develop successors, we launched the Meiji Home Delivery Service Academy (training program for young leaders willing to take over businesses) and the Meiji Home Delivery Service Symposium (sharing examples of successfully run businesses) on an ongoing basis. We also sponsor the Milk Staff of the Year award to recognize outstanding distributor staff members. In these and other ways, we work to train and improve the skills of distributor personnel.

Respond to a Super-Aged Society



KPI

Develop products that contribute to a super-aged society

FYE 3/2019

✓ Products That Contribute to a Super-Aged Society : 6 items

Develop Products That Contribute to a Super-Aged Society

Through original research and nutritional design, we offer products for consumers to take in the nutrient content and energy they require.

Approach

Developing Delicious, Easy-to-Use Nutrition and Liquid Foods for the Elderly

We conduct product research and development related to malnutrition. One of our strengths is the unique nutrition engineering technology we have accumulated through many years of research on infant formula. We design the nutrition of food products for the elderly based on clinical nutrition research focused on this consumer segment. Moreover, we improve existing products to make them easier to handle and drink at home.



Meiji Inslow
(Enteral Formula)



Nutrition
Meiji Mei Balance



Slurry Preparation
Food



Meiji Mei Balance
(Enteral Formula)

Our FYE March 2019 Progress

Develop products That contribute to a Super-Aged Society : 6 items

Meiji Nutrition Up Paste



Open Innovation

We have entered new research fields, including regenerative medicine and advanced medicine. We have started joint research in regenerative medicine with RIKEN Center for Developmental Biology, and we have undertaken collaborative drug discovery research related to autoimmune diseases and cancer with the Foundation for Biomedical Research and Innovation.



Institute of Biomedical Research and Innovation

Link

[■ KOBE Life Science Cluster Company List](#)

■ Conduct Educational Activities Aimed at Preventing Malnutrition

Japan has become a super-aged society, with more than a quarter of its population over the age of 65 years. While obesity and metabolic syndrome have attracted much attention, some elderly people suffer from malnutrition. Malnutrition means having insufficient nutrition to be active due to inadequate intake of food and protein. The elderly suffer from malnutrition because they eat less, or because their diets lack variety. These habits stem from changes in living situations or from the weakening of bodily functions with age.

Approach

Seminars About Malnutrition for Healthcare Professionals and the Elderly

We conduct educational activities focused on malnutrition and malnutrition prevention. Our goal is for the elderly to avoid malnutrition and lead active daily lives. We hold seminars about malnutrition and malnutrition prevention, targeting healthcare professionals at in-home-care support centers, drug store employees, and the elderly. Specifically, we provide information about nutrition and meals recommended for the elderly. We also discuss the preparation of meals that are easier to eat for elderly people who have difficulty swallowing.



Seminars about malnutrition and malnutrition prevention

Publishing Information via Our Website

We publish information about malnutrition on our Japanese website.

Improve Nutrition in Emerging Countries

■ Communicate Information on Nutrition Improvement in Emerging Countries

Many people in developing countries and emerging economies suffer from nutritional deficiencies and malnutrition.

As a company in the food business, we want to help solve these issues, working with groups that encourage nutrition improvement to raise awareness about diet and nutrition through educational activities.

Approach

Nutrition Improvement in Emerging Countries

Over time, Japan has overcome its own historical malnutrition issues through school lunch programs and nutrition education policies. The private sector has contributed via food development and supply, offering excellent insights and good practices related to nutritional improvement. Japan has also worked to solve the diseases and illness arising from over-nutrition, including obesity, noncommunicable diseases, and micronutrient deficiency on a variety of levels. At the same time, people in developing and emerging countries face nutritional deficiencies and malnutrition. The severity and urgency of this issue is covered in the news globally.

The Government of Japan announced that it will lead public-private partnerships for nutrition improvement, amplifying global efforts to improve nutrition in the lead-up to the Tokyo 2020 Olympic and Paralympic Games. In a health and medical care strategy formulated in 2014, the

Japanese government set a goal to boost the international business initiatives based on public-private partnerships, as well as other activities aiming to improve nutrition in emerging and developing countries.

The Nutrition Japan Public Private Platform (NJPPP) was established in 2016 to achieve this goal. This platform aims to promote nutritional improvement through collaborations in the public and private sector, facilitating the business environment for food companies engaged in nutritional improvement activities in developing countries. The platform also advances initiatives targeting the creation of shared value beyond corporate social responsibility to expedite corporate growth and resolve current issues in society. Meiji Co., Ltd. joined the NJPPP in 2016.

Link

■ [Nutrition Japan Public Private Platform \(NJPPP\)](#)

■ JICA Project

The Food segment is developing a business in Vietnam to promote nutrition awareness and improve nutrition among female factory workers. This business was selected as an SDG support enterprise by the Japan International Cooperation Agency (JICA). Under this project, companies in Vietnam purchase nutritionally fortified milk for women from this enterprise, providing or selling this milk to female factory workers to improve health among employees. Our aim is to promote sales and improve dietary practices through employee nutrition education.



Ensure the Sustainable Supply of Pharmaceuticals

Ensure the Sustainable Supply of Drugs for Infectious Diseases, Drugs for Central Nervous System Disorders, Generic Drugs, and Vaccines

Our Pharmaceuticals business has developed an infrastructure to ensure a reliable, stable supply of drugs in Japan and throughout the world. The business has conducted a risk assessment, preparing a supply network capable of responding flexibly to any unforeseen circumstances.

Approach

Optimization of Production Site Allocations in Japan and Overseas to Ensure Stable, and Low-Cost Supply

We have optimized our production site allocations in Japan and overseas (Thailand, Indonesia, India, and China) to form a network ensuring the stable, and low-cost supply of drugs.

Sustainable Supply of Vaccines

KM Biologics Co., Ltd., has become a wholly owned consolidated subsidiary since July 2018. This company researches, develops, manufactures, and supplies an extensive range of human and veterinary vaccines, and blood plasma products.

Manufacturing Vaccines That Combat New Strain of Influenza Viruses

As a recipient of a grant from the Japanese Ministry of Health, Labor and Welfare (MHLW)'s Influenza Vaccine Production Process Development Project, we are working to expand production capacity to accommodate the vaccination needs of 57 million people (almost half the population of Japan) in preparation for an influenza pandemic.

Single-Supply Products*

We have a number of single-supply products including habu (poisonous snake) antivenom, a hepatitis A vaccine, anthrax vaccines for animals, and a range of diagnostic agents.

* Single-Supply Products : Products only manufactured by a single pharmaceutical company in Japan. No alternative products are available in Japan.

Developing and Supplying Orphan Drugs*

We manufacture seven orphan drugs approved by the MHLW (as of July 2, 2018).

* Orphan Drugs : Drugs specified by the MHLW for the treatment of diseases with less than 50,000 patients in Japan who require a high level of medical care.

Link

[KM Biologics Co., Ltd.](#)

Access to Medicine

We collaborate with certain organizations to improve access to medicine in developing and emerging countries.

■ Supply Patients with *KANAMYCIN* Through Stop TB Partnership

We are helping improve access to pharmaceuticals in emerging countries by supplying the antituberculous drug *KANAMYCIN*. Currently, it is estimated that there are approximately 10 million tuberculous patients per year in the world, and 5% or 500,000 of those patient have multidrug-resistant tuberculosis. *KANAMYCIN* is effective against multidrug-resistant *Mycobacterium tuberculosis*. We have been supplying approximately 140,000 patients with *KANAMYCIN* through a United Nations project called the Stop TB partnership since 2011. The goal of this project is to



Source : Stop TB Partnership

bring an end to this global epidemic. To achieve this, the project plans to improve access to pharmaceuticals in remote areas of Asia and Africa. We are also working to obtain data by 2020 to show that *KANAMYCIN* can be stored for more than 5 years, even in hot and humid conditions. We shall continue to provide a stable supply of high quality pharmaceuticals to help stop tuberculous.

Link

[Stop TB Partnership](#)

[Partner's Profile of Stop TB Partnership](#)

■ Medreich Contributes to Medicine Access Through UNICEF

Medreich Limited is a contract manufacturing organization (CMO) and contract development and manufacturing organization (CDMO) conducting pharmaceutical-manufacturing business in India. The company manufactures generic drugs and sells them to markets worldwide, including Europe, Asia, Africa and Oceania. Medreich plc is a sales company based on U.K. which sells pharmaceutical products manufactured in Medreich Limited mainly for EU market. Medreich plc supplies the antibiotic *Amoxicillin* to UNICEF. Medreich will continue to contribute to children's access to medicine through UNICEF.

* UNICEF : United Nations International Children's Emergency Fund

Link

[Medreich Limited](#)

[Locaion of Medreich Limited](#)

[UNICEF](#)

■ KM Biologics is Developing a Novel Vaccine for Dengue

KM Biologics is developing a novel vaccine (KD-382) for dengue which is wider spread in tropical and sub-tropical climates worldwide including the developing nations. KD-382 is a live attenuated tetravalent dengue vaccine containing each live attenuated dengue virus for four dengue serotypes 1 to 4 (DENV1-4) as the active ingredients and is expected to provide preventive effect against

dengue. KD-382 has shown good immunogenicity and protective efficacy for all four serotypes with a single dose administration in the non-clinical studies. KM Biologics is conducting the Phase I clinical trials.

Measures Against Infectious Diseases

Depending on the economic climate, public health system and access to pharmaceuticals throughout the world, patients can't always be administered the appropriate antibiotics for the right dosage and/or for the appropriate treatment period. This is one of the reasons for the emerging antimicrobial resistance (AMR). Asia and Africa in particular are more at risk to infections caused by drug-resistant bacterium, and more than 10 million fatalities are estimated to be caused by these infections in 2050. The Meiji Group will use our expertise to reinforce countermeasures to fight against drug-resistant bacteria and to address this social issue.

Public Awareness Activities Concerning Antimicrobial Resistance (AMR)

As one of the Meiji Group's initiatives, we are carrying out public awareness activities in collaboration with related organizations. We have joined the AMR Stewardship project sponsored by the Japan Pharmaceutical Manufacturers Association and have created posters and video under the keyword Stop AMR. We have asked healthcare related organizations to put up our posters and show our video to help raise public awareness. We are also involved in other activities that help disseminate information on AMR to medical institutions.



New Drug Research and Development

Due to a recent rise in microbes resistant to conventional antibiotics, the international community has been confronted with a major concern on how to counteract antimicrobial resistance (AMR). We have been researching and developing antibiotics for many years, and we are committed to finding a solution to counteract AMR.

Approach

Our competitive edge in R&D is attributed to our long experience and involvement in antibiotics research, and has earned us the deep trust from medical institutions. We have amassed a huge amount of data collected from drug sensitivity testing for resistant strains of bacteria, which medical institutions sent to us. We promote R&D based on the practical needs at hospitals, because we stay informed on the latest trends involving infectious diseases.

We dedicate more resources to R&D on β -lactamase (bacterial enzyme that breaks down antibiotics such as penicillin and induces drug resistance) in response to the growing needs of medical institutions for drugs counteracting resistant bacteria. We have successfully discovered 'nacubactam' (development code : OP0595), which, in combination with β -lactam antibiotics, restores or extends their ability to treat bacterial infections caused by beta-lactamase producing antibiotic-resistant strains.

The Phase I clinical trials have been completed in the United States. At the same time, Meiji's β -lactamase inhibitor OP0595 project, entitled "Development of a novel β -lactamase inhibitor, OP0595, as a single drug utilizing a new rapid genetic diagnosis and non-clinical PK/PD theory" has been adopted by Japan Agency for Medical Research and Development (AMED) grant for 'Cyclic Innovation for Clinical Empowerment (CICLE)'. The Phase I clinical trials are conducted in Japan. We expect that this new candidate will combat AMR, and we shall continue to carry out our social responsibilities through revolutionary drug discovery.

Quality and Safety

SDGs



Social Issues

- Ensure Product Quality and Safety

KPI Obtain Global Food Safety Initiative (GFSI) certification, which includes Hazard Analysis and Critical Control Points (HACCP) for all domestic food plants by FYE March/2021

FYE 3/2019 50% : Newly 6 factories, Total 24 factories

Ensure Product Quality and Safety

Safety System Initiatives for Trusted Quality, Brand Recognition

Food Segment Quality Control

The Meiji Group provides high-quality, safe products and services to meet customer expectations for related health and reliability. Through these efforts, we will improve the lifestyles of our customers. Based on our Corporate Behavior Charter, the Meiji Group strives to improve the quality of our products through quality assurance systems developed in house, tailored to the specific characteristics of each business operation. Meiji Co., Ltd. has established an original quality management system, which includes Quality Policy, Quality Assurance Regulations, and Quality Assurance Standards. Each functional division (development and design, procurement, manufacturing, logistics, and sales and communications) conducts operations based on the Quality Policy. Quality Assurance Regulations stipulate important items for maintaining quality, and Quality Assurance Standards detail specific duties and assessment criteria.

The Food segment has adopted Meiji Quality Communication, conducting stringent quality control under an integrated system spanning raw material procurement through sales.

Our hygiene control system covers all domestic food plants, and is based on the Hazard Analysis and Critical Control Point (HACCP). We intend to obtain Global Food Safety Initiative (GFSI) certification for all domestic food plants by FYE March/2021.

We test products through various means, including physical and chemical tests, before shipment. Through a range of tests, we check whether products have been manufactured in accordance with established procedures.

Our FYE March 2019 Progress

Obtain Global Food Safety Initiative (GFSI) Certification for 50% (24 plants) of domestic food plants.
Obtain Global Food Safety Initiative (GFSI) Certification for 67% (4 plants) of overseas food plants.

Quality Policy

We intend to widen the world of Tastiness and Enjoyment to meet all expectations of Health and Reassurance, providing our customers with Promised Quality and offering shared value. As Food and Health professionals dedicated to food quality and safety, our responsibility is to meet customer expectations according to three central principles:

1. We promise to enforce strict quality assurance at every step in our food chain, implementing the best system possible in each division and product to ensure Promised Quality.
2. We promise to maintain a close relationship with our customers and respond immediately to customer inquiries, questions, and concerns. We will maintain the trust of our customers by striving to understand and satisfy their expectations.
3. We promise to comply with all applicable laws and regulations, providing safe, high-quality products and services.



Link

[Quality Management System in Food Segment](#)

Quality Assurance Advancement System

In the Food segment, the Meiji Quality Comm Review Meeting leads quality assurance advancement activities. Held biannually and chaired by the president and representative director of Meiji Co., Ltd., the meeting checks the progress of quality related initiatives and discusses measures to address issues. Further, the Food segment's Meiji Food Safety Committee is chaired by the Director of the R&D Division and discusses a wide range of topics approximately twice a year. The committee invites experts in such fields as food chemicals and microorganisms to identify and reduce food risks.

Also, in the Food segment, members of one of the specialized teams from our Quality Division audits compliance with Quality Assurance Regulations according to a prepared checklist. These audits identify issues and improve our quality assurance capabilities.

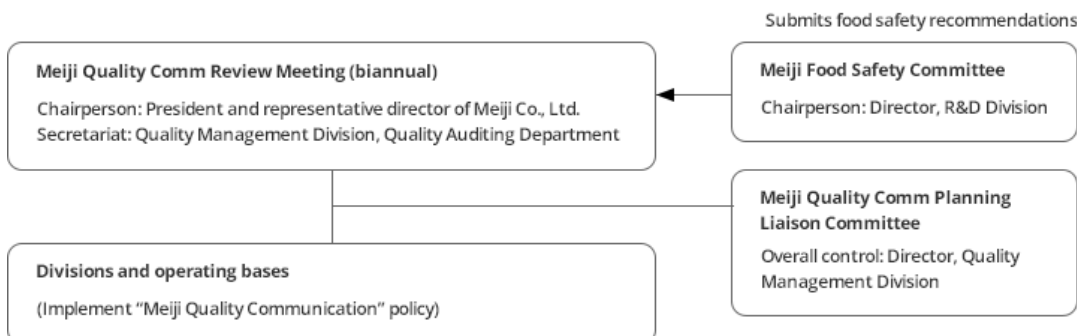



Approach

Working With Suppliers for Consistent Quality Management

We work with suppliers to prevent quality defects and risks arising from raw ingredients or equipment. In the event of an issue, we perform a detailed investigation and share information, striving to prevent the recurrence of any similar problems.

Quality Audits by Internal Expert Teams

Teams of experts from our Quality Management Division perform quality audits based on detailed checklists. These audits ensure strict compliance with quality assurance regulations and other rules. The goal of these audits is to identify issues and improve our ability to assure quality. During FYE March/2018, we performed audits within Meiji Co., Ltd. and group companies inside and outside Japan. Auditors shared quality assurance information from Japan at overseas plants, being considerate of local customs and culture.

Incorporating Customer Feedback Into Quality Assurance Activities

We have established special divisions to analyze customer feedback. We have a monitoring system in place to capture customer feedback, particularly comments that could indicate health hazards. These divisions respond rapidly to feedback requiring an urgent response, performing cross-division confirmation and analysis of information.

Internal Quality Training

Meiji invests considerable time and effort in human resources training to improve quality levels. We hold seminars for both manufacturing and sales staff.

Quality Improvement Activities for Improved Production Floor Competence

Each production plant engages in quality improvement activities to reduce mistakes, process errors, and other issues, as well as to improve competence on the production floor. During FYE

March/2018, a total of 211 teams from throughout our group companies conducted quality improvement activities.

Quality Management Based on Reliability Assurance Systems

Pharmaceutical Segment

Reliability Assurance for Pharmaceuticals and Medical Devices

The Pharmaceutical segment's Reliability Assurance Policy assures the reliability of pharmaceuticals and medical devices. This policy states, "We will contribute to society by earning the trust of patients and healthcare professionals."

Accurate information is essential for the appropriate use of pharmaceuticals. We make available to users all information relevant to our products, which we obtain during product development, clinical studies, and post-marketing surveillance.

Based on the Reliability Assurance Policy, we have established the Reliability Assurance Guidelines. Based on these guidelines, we do our best to enhance the reliability of our products and activities.

Reliability Assurance Guidelines and Reliability Assurance System

The Ministry of Health, Labour and Welfare in Japan enforces stringent standards for all aspects of pharmaceuticals, from R&D, manufacturing, and shipment to the gathering of information on adverse reactions and the provision of information on proper use.

At each operational stage, we have established original standards and manuals with adherence to laws and regulations. We ensure the reliability of data and information through rigorous efforts to conduct appropriate tests and gather accurate data. The Reliability Assurance Policy also applies to group companies.

The Reliable & Quality Assurance Division ensures reliability by conducting internal audits, as required, in compliance with standards and policies based on the Reliability Assurance Policy. The Reliable & Quality Assurance Division is independent from R&D, production, and sales divisions. In this way, we have established a system that ensures reliability through objective assessment.

We have established Operational Rules of Quality Management Review. This is a system that achieves continuous improvement through plan-do-check-act cycles aimed at ensuring, and enhancing, product reliability.

Based on the Quality Assurance Policy, the Pharmaceutical segment ensures quality globally. In these activities, we assure quality across the entire supply chain, from raw material procurement and manufacturing to distribution and the post-marketing gathering of information on side effects. For example, we visit our own plants, and those of manufacturing subcontractors and raw material suppliers in Japan and overseas to ensure the quality of our pharmaceuticals. Pursuant to relevant laws, an authorized person approves shipment to market after checking all manufacturing-related records. In this way, we provide pharmaceuticals that healthcare professionals and patients can use with complete confidence.

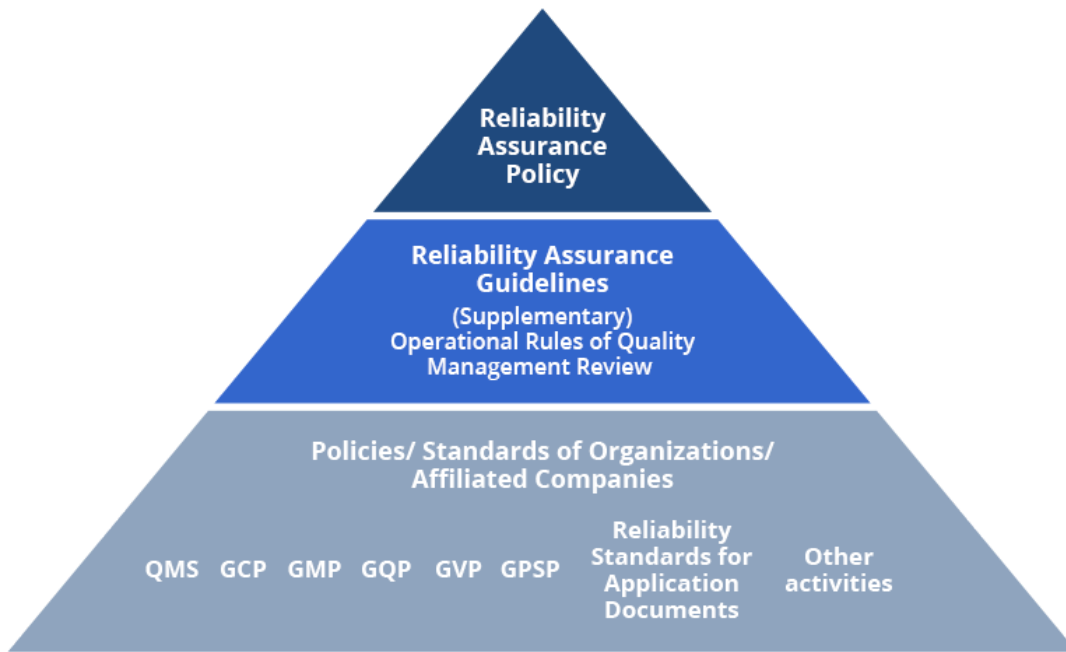

QMS: Quality Management System
GCP: Good Clinical Practice
GMP: Good Manufacturing Practice

GQP: Good Quality Practice
GVP: Good Vigilance Practice
GPSP: Good Post-marketing Study Practice

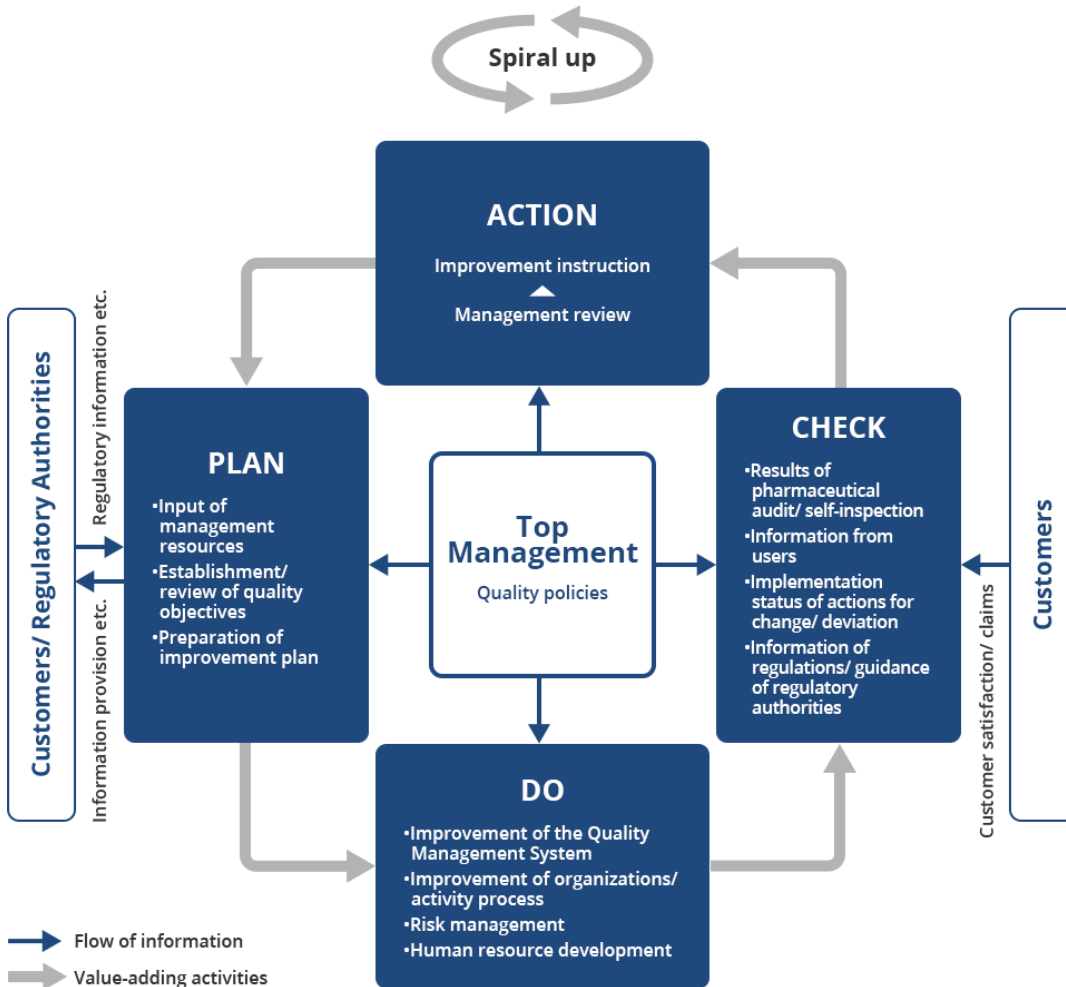

Link

➤ [Quality in Pharmaceutical Segment](#)

Quality Improvement and Personnel Development

We foster the ability of our employees to improve operations proactively. We hold meetings to share and discuss the achievements of quality improvement activities and engage in other activities to develop our personnel.

Response to Quality-Related Incidents

If a quality-related incident occurs, our head office collects quality information from plants, affiliated companies, and the respective divisions involved. This information is summarized and shared with senior management. We take any necessary measures and implement preventive measures as promptly as possible.

Extensive Disclosures on Quality and Safety

We make timely and appropriate disclosures of information related to high-quality, safe products and services, striving to ensure the trust and satisfaction of our customers and patients.

Approach

Disclosures on Our Corporate Websites

We disclose frequently asked questions on our Food segment website. We make timely updates to this content based on popular topics.

Disclosures on Product Quality Assurance

Link

- ▶ [Quality in Food Segment](#)
- ▶ [Quality in Pharmaceutical Segment](#)

Ethical Considerations in R&D

As a leader in food and health, the Meiji Group conducts research activities in pursuit of new health value for our customers. The Meiji Group research and development is conducted in compliance with relevant laws, policies of the relevant ministries and agencies, and internal rules for product quality, efficacy and safety.

Ethical Considerations in Research Using Human Biological Materials

We conduct objective and thorough investigations in terms of scientific and ethical issues prior to engaging in research using biological materials from humans, such as tissues, cells, blood, or genes, as well as information from human subjects. Recently, basic research and regenerative medical research utilizing ES cells, iPS cells, and other biological materials from human subjects has been expanding at a rapid pace. The Meiji Group conducts thorough investigations in bioethics and safety beforehand and complies with national guidelines and guidance* in the use of such human samples and information for research.

* Japanese guidelines, including the Ethical Guidelines for Medical and Health Research Involving Human Subjects and the Ethical Guidelines for Human Genome / Gene Analysis Research

Ethical Considerations in Animal Testing

We create plans that focus on animal protection and welfare, when implementing animal testing. Experiments are based on the 3Rs principle of reduction: using fewer animals; replacement: seeking experiments that do not use animals; and refinement: mitigating animal suffering. We conduct animal testing after receiving approval from a laboratory animal ethics committee. Meiji Group animal experimentation facilities undergo evaluations and certifications from external organizations. Besides, the Food segment will not fund, conduct, or commission any tests on animals for health claims that are not required by law.

Handling of Biohazards and Living Modified Organisms

To handle biohazard materials including pathogenic microorganisms safely, the Meiji Group has established internal rules based on the WHO Laboratory Biosafety Manual. An internal committee overseeing biorisks establishes operating rules for the proper handling of biohazard materials and manages the status of such. In particular, the proper handling of pathogens and other materials

regulated under the Infectious Disease Act*, the Act on Domestic Animal Infectious Diseases Control, and other laws is overseen by an internal expert committee to ensure we handle pathogens etc. in accordance with relevant laws. This committee also ensures we engage in the procedures required (approvals, filings) under such laws.

We have established internal rules and an internal committee to oversee handling of living modified organisms and gene recombination in conformance with the Cartagena Act*. The internal committee examines to ensure experiments using living modified organisms are conducted in line with the standards provided in the Cartagena Act.

* Infectious Disease Act: Act on the Prevention of Infectious Diseases and Medical Care for Patients with Infectious Diseases

* The Cartagena Act: Act on the Conservation and Sustainable Use of Biological Diversity through Regulations on the Use of Living Modified Organisms

Ethical Considerations Related to Medical Research Involving Human Subjects

The Meiji Group conducts product research and development to provide new health value to our customers. Society demands that we confirm the safety and effectiveness of our products through medical research that involves human subjects (clinical trials and clinical research). In conducting clinical trials and clinical research, we exercise respect for the sanctity of life and respect for human rights in conformity with the Declaration of Helsinki*, complying with related laws and regulations* of each country and region and conducting ethical medical research.

When conducting medical research involving human subjects, the Meiji Group give the utmost consideration to protecting the human rights and ensuring the safety of the participants. At the same time, we strive for transparency in our research and to ensure scientific propriety, independence, and reliability. Research ethics committee and institutional review board examine these ethical and safety issues.

* The Declaration of Helsinki: Standards for ethical medical research involving human subjects

* Japanese guidelines, including the Ethical Guidelines for Medical and Health Research Involving Human Subjects



The Pharmaceutical segment receives accreditation from the Japan Health Sciences Foundation (JHSF).

Caring for the Earth

SDGs



We are fully aware that our business operations depend upon the bounty of nature. We strive to conserve resources, protect the environment, and contribute to a more sustainable society. The Meiji Group is committed to reducing the environmental impact of our business activities. We conduct business operations in accordance with our Environmental Philosophy and Environmental Policy, which aim for harmony with the environment.

Environmental Management

■ Social Issue

▶ Environmental Management

Climate Change



■ Social Issue

▶ Reduce CO₂ Emissions

- ▶ Energy Conservation Measures
- ▶ Renewable Energy
- ▶ Carbon Emissions Trading
- ▶ Improved Environmental Data Management

▶ Eliminate the Use of Specified Fluorocarbons

- › Switch to Alternative Fluorocarbons and Natural Refrigerants

Circular Economy



■ Social Issue

🔴 Reduce Environmental Impact

- › Addressing Food Loss and Waste
- › 3Rs (Reduce, Reuse, Recycle)
- › Reduce Final Disposal Volume
- › Appropriate Chemical Substance Management

Water



■ Social Issue

🔴 Secure Water Resources

- › Appropriate Water Management and Water Risks

Biodiversity



■ Social Issue

🔴 Secure Local Biodiversity

- ▶ Biodiversity Conservation

Environmental Management

Environmental Management

Environmental Philosophy

Recognizing that our business operations originate from the bounty of nature, the Meiji Group will contribute to the creation of a sustainable society. To this end, we intend to harmonize our business activities with the global environment and manage the group in a way that protects the environment.

Approach

Environmental Management System

There is The Group Environmental Meeting, which is made up of representatives from our Food segment and Pharmaceutical segment as well as the sustainability representatives from Meiji Holdings Co., Ltd. Under this system, the Meeting sets a long-term vision, plans specific measures as well as carries out risk management, and essentially oversees the environmental management for the whole Group.

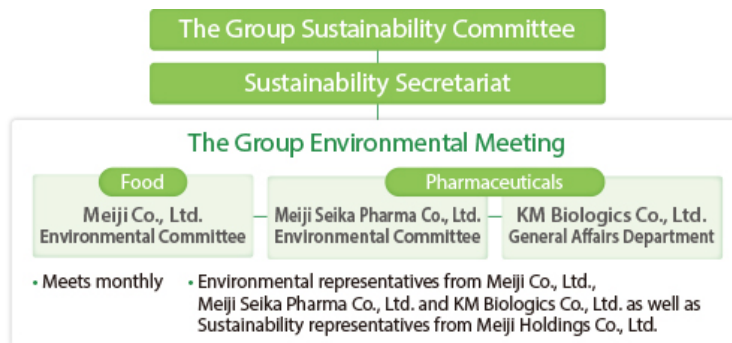

Third-Party Certification

Food Segment

ISO 14001 : Multisite

Eco-Action 21 : One group company

Pharmaceutical Segment

ISO 14001 : Two plants, four research laboratories and one group company

- ▶ Food segment Multi-site (PDF:1449KB)
- ▶ Pharmaceutical segment, Odawara Plant (PDF:188KB)
- ▶ Pharmaceutical segment, Gifu Plant (PDF:400KB)
- ▶ Pharmaceutical segment, Bioscience Laboratories, and CMC* Research Laboratories (Ashigara) (PDF:201KB)
- ▶ Pharmaceutical segment, Pharmaceutical Research Center, CMC Research Laboratories (Yokohama), and Agricultural & Veterinary Research Laboratories (PDF:726KB)
- ▶ OHKURA Pharmaceutical Co., Ltd. (PDF:527KB)

* CMC: Chemistry, Manufacturing & Control

Endorsing the TCFD, Joining the TCFD Consortium

Meiji Holdings Co., Ltd. has endorsed the

recommendations of the Task Force on Climate-related Financial Disclosures (TCFD) established by the Financial Stability Board*1, and has participated in the TCFD Consortium*2.



*1 An international organization of representatives of central banks, financial supervisory agencies, and finance ministries.

*2 A consortium for investors and companies supporting the TCFD to jointly develop and use industry-specific scenario analysis and quantification techniques.

Material Balance (Fiscal Year Ended March 2019)

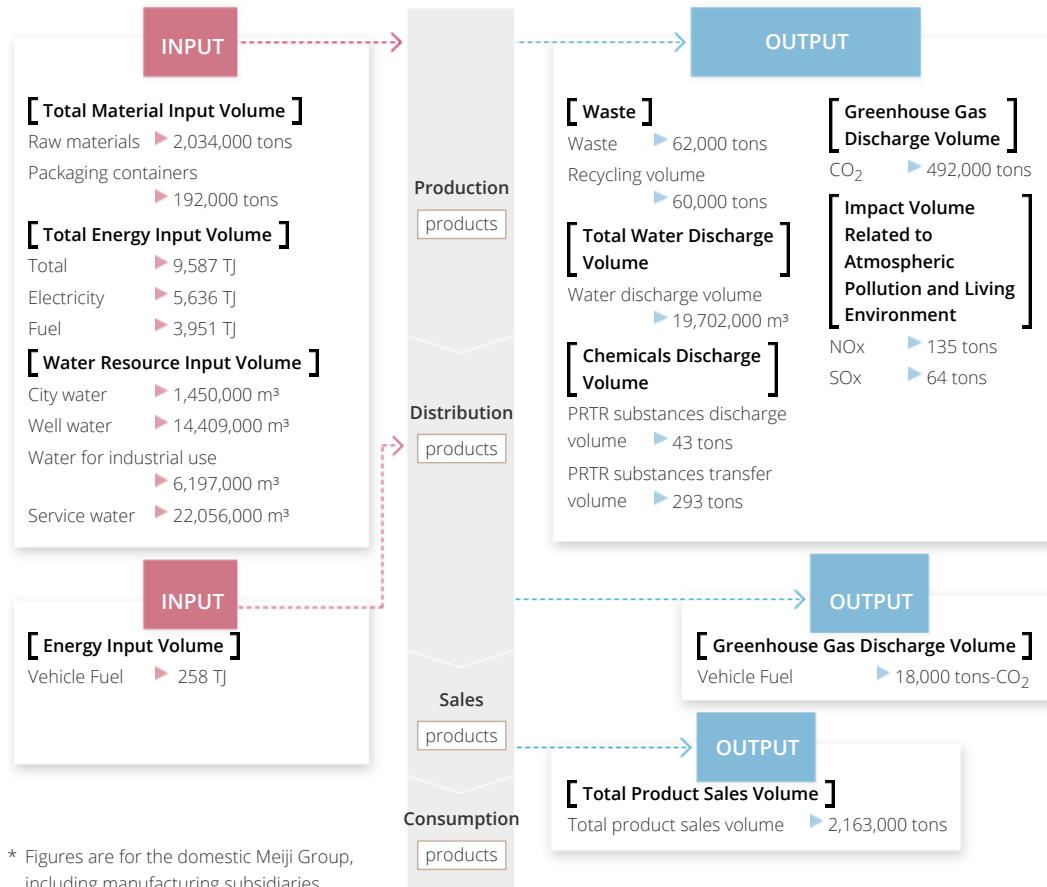

Environmental Accounting

We calculated environmental preservation costs and economic effects for FYE March/2018 based on guidelines furnished by the Ministry of the Environment in Japan.

Environmental accounting figures are based on totals for Food segment and Pharmaceutical segment. Calculating investments, costs and economic benefits for environmental preservation encourages greater efficiency in Meiji Group activities.

Environmental Preservation Costs Millions of yen

Details	FYE 3/2016		FYE 3/2017		FYE 3/2018	
	Capital expenditures	Costs	Capital expenditures	Costs	Capital expenditures	Costs
Costs within business						
Total	698	4,213	621	4,237	837	4,705

Details	FYE 3/2016		FYE 3/2017		FYE 3/2018	
	Capital expenditures	Costs	Capital expenditures	Costs	Capital expenditures	Costs
Pollution prevention costs Air pollution control, Water pollution control, Soil pollution prevention, Stink prevention, Land subsidence prevention, etc.	321	2,849	137	2,784	147	3,071
Environmental preservation costs Implementation of energy saving and greenhouse reduction measures, etc.	354	575	478	569	673	705
Resource circulation costs Global warming prevention, energy saving, ozone depletion prevention, etc.	23	619	6	692	2	791
Upstream and downstream costs Environmentally sound procurement and purchase	0	2	0	40	14	5
Management activity costs Disclosure of environmental information and activities and operation of environmental management system	1	146	0	131	0	115
Research and development costs Research and development for reducing environmental impact	0	0	0	0	0	0
Social contribution costs Nature conservation and tree-planting activities	0	13	0	12	2	8
Total	698	4,213	621	4,237	837	4,705

Details	FYE 3/2016		FYE 3/2017		FYE 3/2018	
	Capital expenditures	Costs	Capital expenditures	Costs	Capital expenditures	Costs
Environmental damage costs						
Natural resource restoration	0	9	0	9	0	10
Total	698	4,213	621	4,237	837	4,705

Economic Effects of Environmental Preservation Measures (Millions of yen)

Details	FYE 3/2016	FYE 3/2017	FYE 3/2018
	Benefit	Benefit	Benefit
Energy saving	143	131	182
Waste reduction	37	28	23
Sale of valuables	105	78	58
Total	285	237	263

* Calculation parameters

Scope: Meiji's and Meiji Seika pharma's plants and research centers, respectively.

(1) Totals were calculated based on environmental accounting standards prepared in accordance with the Environmental Accounting Guidelines of the Ministry of the Environment.

(2) Costs include depreciation and amortization, personnel expenses, utility costs, repair costs, and other costs.

(3) Depreciation and amortization was calculated by identifying environmental equipment and facilities in the fixed asset ledger and using their statutory useful life.

Climate Change

SDGs



Social Issues

- Reduce CO₂ Emissions
- Eliminate Specific CFCs

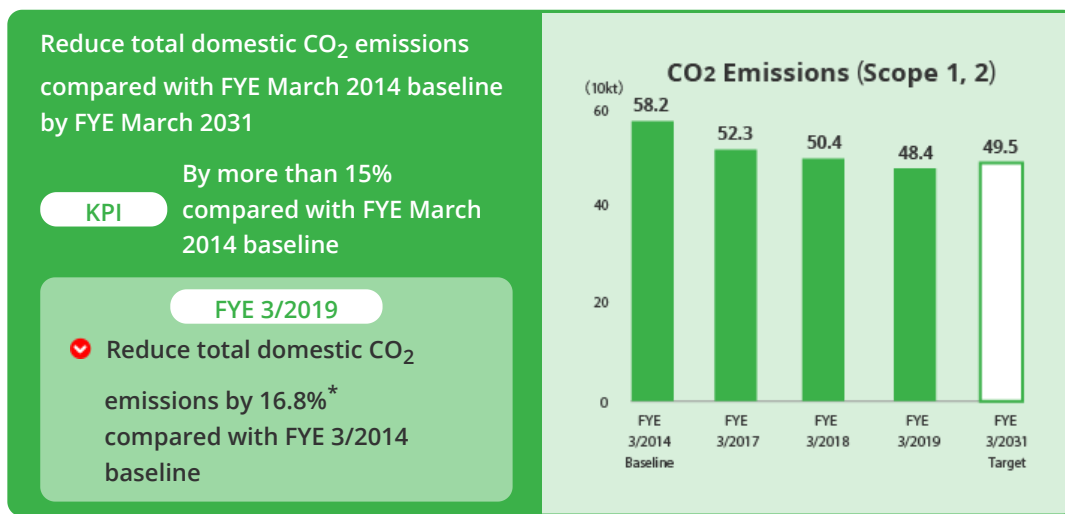

* excluding KM Biologics Co., Ltd.

Reduce CO₂ Emissions

Energy Conservation Measures

We strive to conserve energy and resources by installing energy efficient equipment, improving existing production equipment, and converting to energy sources with lower CO₂ emissions.

Approach

Energy Consumption and CO₂ Emissions

We are working to conserve energy and reduce CO₂ emissions during production by converting from heavy oil to municipal gas. We also make use of in-house cogeneration systems that utilize waste heat efficiently.

- Climate Change (PDF:350KB)

We upgraded the once-through boiler* at Pharmaceutical Research Center in Pharmaceutical segment to a high-efficiency unit, saving 200 tons of CO₂ emissions annually

* Equipment that creates a heat source (steam, hot water) by using fuel to heat water.



Pharmaceutical Research Center
in Pharmaceutical segment

Eco-Friendly Logistics via Modal Shifts and Double-Deck Trucks

At Meiji, we strive to reduce our environmental footprint in materials procurement, product delivery, and other logistics operations. We have introduced modal shifts and double-deck trucks to transport products of differing temperature zones on a single vehicle.

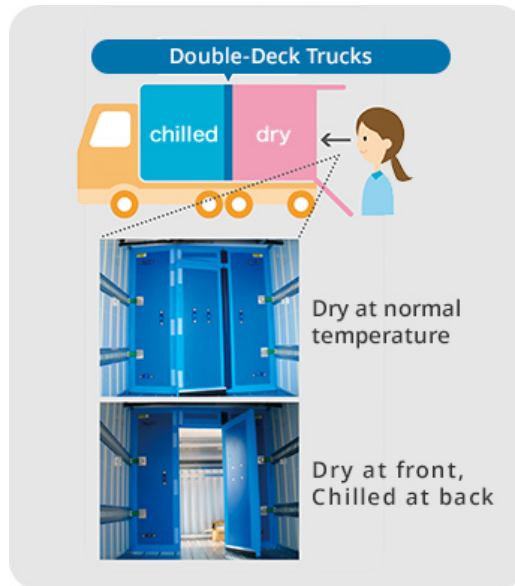

Changeover to Low-Emission Vehicles; Fleet Reductions

We began changing our delivery trucks and sales vehicle fleets to eco cars in FYE March/2013. We have also cut down the size of our sales vehicle fleet.

Results

Number of Eco Cars (vehicles)

FYE March/2015	460
FYE March/2016	546
FYE March/2017	629
FYE March/2018	508
FYE March/2019	558

Renewable energy

Approach

Solar Power Generation at Meiji Production Plants

We use renewable energy to reduce CO₂ emissions. Some Plants have installed solar panels.

Results

FYE March/2019

Osaka Plant

Power generation volume: 228,455 kWh (power generation capacity: 200 kW)

CO₂ reduction volume: 99 ton

Aichi Plant

Power generation volume: 989,610 kWh (power generation capacity: 750 kW)

CO₂ reduction volume: 471 ton

Laguna Cookie Co., Inc. , Santa Ana Plant

Power generation volume: 106,630 kWh (power generation capacity: 270 kW)

CO₂ reduction volume: 54 ton

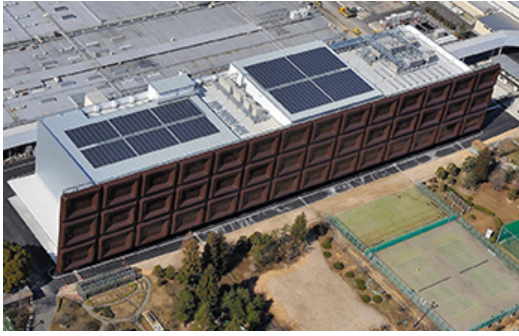

Osaka Plant



Aichi Plant



Santa Ana Plant



Santa Ana Plant

Generating Electricity via Bioenergy

In addition to the use of activated sludge processing at Sakado Plant and at Meiji Chewing Gum Co., Ltd., we are incorporating discharged water treatment technology that utilizes methane fermentation*. We use methane gas as a fuel for boilers.

* Methane fermentation treatment method - Treatment method that uses anaerobic microorganisms (absence of oxygen) to break down organic solids in discharged water, converting them to methane gas and CO₂.



Methane fermentation process
(Sakado plant in Food segment)

Carbon Emissions Trading

We use renewable energy sources (solar power, etc.) and adopt the carbon emission trading system to reduce greenhouse gases, a contributor to climate change.

Improved Environmental Data Management

We continue to improve our environmental data management system, which provides evidence of our initiatives dealing with climate change and global warming. In addition to consolidated group data collection and disclosure, we have an independent entity draft group management standards and perform audits to verify our environmental management system operations, as well as improve our data transparency and reliability.

Approach

Improved CO₂ Management System

In addition to acquiring data from our worldwide operations, we are considering whether to adopt global management standards and environmental data management systems.

Disclosure of Scope 1, 2, and 3 data

➤ Scope 1, 2, and 3 data (PDF:350KB)

Independent Practitioner's Assurance of CO₂ Emissions

In order to improve the reliability of the data, we obtained the independent practitioner's assurance for the domestic CO₂ emissions (Scope 1, 2 and Scope 3 category 1) of FYE March 2019 indicated on p.42 in the Integrated Report 2019 by Deloitte Tohmatsu Sustainability Co., Ltd. We will work hard to improve the reliability of all environmental data.

- Results of the Domestic CO₂ Emissions (Scope 1, 2 and Scope 3 category 1) in FYE March 2019 (PDF:788KB)
- Independent Practitioner's Assurance Report (PDF:198KB)

Eliminate the Use of Specified Fluorocarbons

KPI Eliminate the use of specified fluorocarbons in air conditioners and large-scale facilities in Japan by FYE March 2036.

Our Results ✓ Switch to Alternative Fluorocarbons and Natural Refrigerants

Switch to Alternative Fluorocarbons and Natural Refrigerants

We are moving our large-scale facilities to natural refrigerants (ammonia, etc.) as an alternative to specified fluorocarbons (R22, etc.) used widely in air conditioners today.

Approach

Switch to Alternative Fluorocarbons and Natural Refrigerants

Some Plants in Food segment have adopted natural refrigerants, reducing CO₂ emissions as a result.

- FYE March /2016 : Kyoto Plant, Gunma Plant
- FYE March /2018 : Kyushu Plant
- FYE March /2019 : Kyoto Plant, Moriya Plant, Tokai Meiji Co., Ltd.



Kyushu Plant

Circular Economy

SDGs



Social Issues

Reduce Environmental Impact

KPI Resource recovery ratio per year (domestic Meiji Group companies)
Achieve 97% or greater

FYE 3/2019 95.6%

KPI Reduce domestic food product waste by at least 50% compared with FYE March 2017 baseline by FYE March 2026

FYE 3/2019

- Reduce Bad Inventory Through Improved Supply Forecasts
- Extending Expiration Dates for Certain Items
- Best-Before Date Changed to Month-Year Label
- Working with Food Banks to Reduce Food Loss

Reduce Environmental Impact

Reduce Final Disposal Volume

The Meiji Group strives to protect the Earth's finite natural resources by reducing waste and using resources efficiently.

Approach

Reducing Production Plant Waste

Food segment is working to reduce waste in every production plant.

Results

Food segment has reduced production waste by an annual 24 tons by changing to intermittent nozzle operation in biscuit dough mold release oil equipment (Galbo chocolate snacks).

Environmentally-Friendly Products

We are minimizing containers and packaging to eliminate waste of precious resources.

Results

Meiji Probio Yogurt, Drink Type

We are reducing the weight of PET bottles for this product. We reduced PET plastic volume by approximately 26% per bottle compared to bottles used prior to the integration of new facilities.



Chocolate Snacks: Kinoko no Yama, Takenoko no Sato

Reduced the thickness of internal packaging by 5 µm, reducing resource usage volume by approximately 9% and annual use by 7.5 tons.



Chocolate Snacks: Galbo Pocket Pack

We reduced packaging volume by approximately 25%



Waste Recycling

Kyushu Plant in Food segment concluded a contract with a local municipal authority in 2013. Under this contract, raw garbage is collected from the plant and fermented at the municipal authority's biomass plant to produce methane. The methane is then used for gas-fired power generation. And dregs from fermentation are used as fertilizer. We donate some of the money saved through this project to promote the local area's agriculture.

Food Segment Plastic Resource Recycling Policy

Plastic waste in the world's oceans has been identified as a significant issue in the global environment. Working with our business partners, Meiji continues to support plastic resource recycling efforts in the following ways.

1. We are changing the design of plastic containers and packaging to minimize the amount of material used while maintaining the beneficial aspects of plastics such as the preservation of product quality. For example, we have reduced the weight and wall thickness of PET bottles and other plastic containers. We are also moving to switch from plastic to paper containers.
2. Meiji works to replace materials used in plastic containers and packaging with environmentally friendly plant-derived materials, materials easier to recycle, and the use of recycled materials themselves. We are also studying the use of biodegradable plastics.
3. Through recycling contractors, we encourage the reuse in recycled products of plastic waste generated in our manufacturing processes.
4. Meiji is also working on recycling and methods to reduce the use of plastics in logistics. For example, we are switching from plastic crates (plastic return boxes used in product delivery) to cardboard boxes.
5. To protect the marine environment, Meiji helps beautify communities and conducts coastline cleanup activities to reduce the amount of plastic trash that flows into oceans through rivers and coastlines.

Addressing Food Loss and Waste

Food loss is defined as otherwise consumable food that is thrown out by food processors, retailers, food service industry entities, households, etc. Annual food loss is estimated to be 6.43 million tons

in Japan alone in FYE March/2017. The Meiji Group acknowledges our own large volume of food loss as part of a larger social issue. We are working with our national government and trade organizations to introduce new policies (below).

Approach

Reduce Bad Inventory Through Improved Supply Forecasts

We are encouraging sales and production division to communicate better. At the same time, we are developing supply forecasts by product, reflecting past sales data and sales promotion plans. As we improve supply forecasts day by day, we limit bad inventory and reduce food loss.

Best-Before Date Changed to Month-Year Label

By changing food expiration labels from year-month-date to year-month formats, we expect to reduce food loss and encourage logistics efficiencies across our entire supply chain as our manufacturing, logistics, and sales teams work more closely together. The best-before date of all products (except gummy and snacks in our confectionery business) will be changed to a month-year label.

Extending Expiration Dates for Certain Items

We plan to extend the expiration dates of certain food items whose quality will not be affected (confectioneries, drinks, nutrition foods, prepared foods, etc.). In so doing, we will reduce wasted stock of expired items.

Results

【Confectionery Business】

- Chelsea Scorchassort ⇒ Extended from 12 months to 15 months (beginning April 2015)
- Cough drops warm ginger ⇒ Extended from 12 months to 14 months (beginning September 2016)

【Nutritionals Business】

- Meiji Mei Balance Mini cup ⇒ Extended from 6 months to 12 months (beginning May 2015)
- Meiji Mei Balance Mini ⇒ Extended from 6 months to 9 months (beginning October 2016)
- Meiji Aquapack Na ⇒ Extended from 6 months to 12 months (beginning May 2017)
- Meiji Mei Balance Rehasupport Mini ⇒ Extended from 6 months to 9 months (beginning December 2017)

Revising the 1/3 Rule Across the Logistics Industry

We are working with trade organizations to revise the traditional 1/3 rule for delivery deadlines.

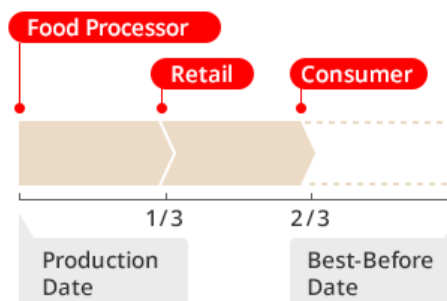

Collaborating With Society

The Meiji Group is working with food banks to reduce food loss.

3Rs (Reduce, Reuse, Recycle)

We focus on environmental friendliness throughout the product life cycle, from planning through disposal.

Approach

Reducing the Environmental Impact of Packaging

Food segment conduct a Paper Drink Carton Recycling Campaign twice per year. The purpose of the campaign is to remind employees of the importance of sorting and recycling paper cartons. Recycling collection boxes are set up, and employees are encouraged to dispose of their paper milk cartons appropriately. Each year the percentage of employees participating increases. At present, approximately 85% of employees participate in the campaigns.



A paper carton collection box



Message to those recycling: "Thank you for recycling"

3Rs for Home-Delivery Milk Bottles

Food segment delivers milk to approximately 2.6 million homes in Japan. The returnable milk bottles used for home delivery must be light and strong so they can be used multiple times. We have recently improved our bottles to make them even stronger and lighter. The weight for a 200ml bottle has been reduced to 180g, while durability has been increased to allow for three times as many uses. If bottles become scratched they can be crushed for use as raw materials for new bottles.

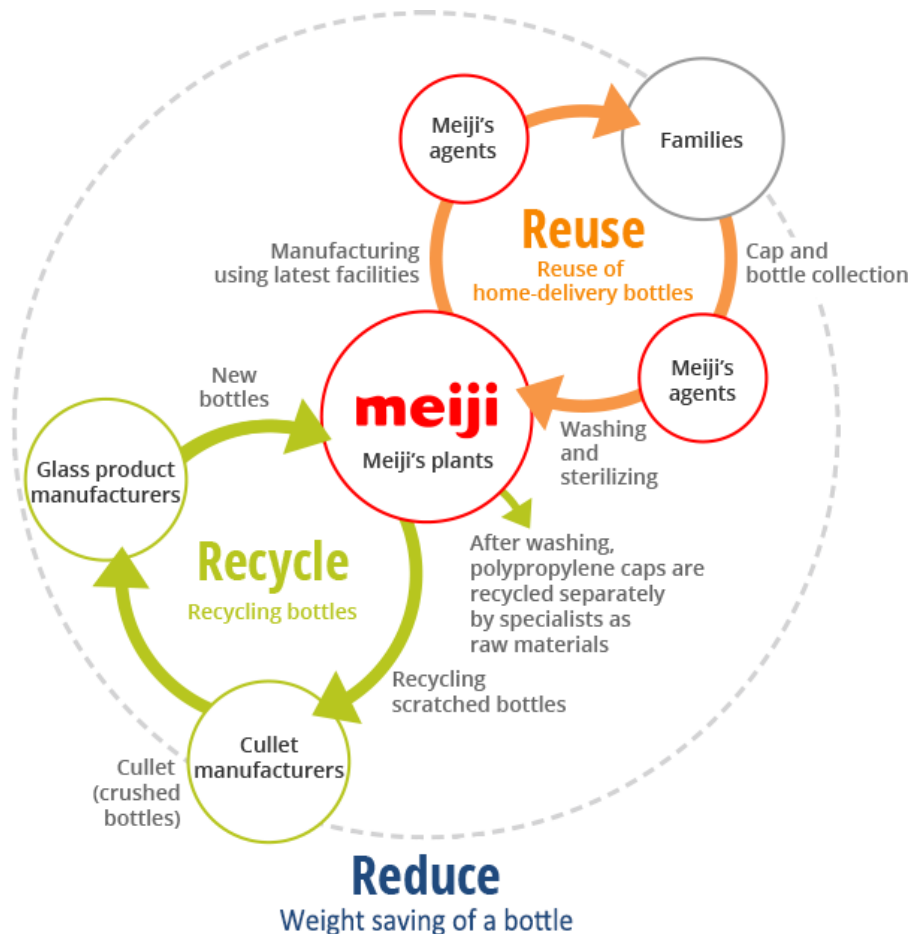

Zero Waste (Zero Emissions)

We pursue a Zero Waste (Zero Emissions) policy based on the 3Rs.

🔗 [Circular Economy \(PDF:350KB\)](#)

Appropriate Chemical Substance Management

We strive to reduce chemical emissions. Measures include equipment to absorb vaporized chemicals, switching to safer substances, and improved manufacturing methods that reduce or

eliminate chemical substances.

Approach

PRTR Substances

We report chemical emissions and transfers in accordance with Japan's Pollutant Release and Transfer Register (PRTR) Act.

At Pharmaceutical segment each pharmaceuticals plant and research center has a chemicals management committee that sets standards for handling chemical substances. The company manages procurement and inventory volumes, checks emission and transfer volumes, and strives to reduce emissions.

[▶ Appropriate Management of Chemical Substances \(PDF:350KB\)](#)

PCB Management

Each of our operating bases engages in the appropriate management of transformers and capacitors that contain polychlorinated biphenyls (PCBs).

Water

SDGs



Social Issues

Secure Water Resources

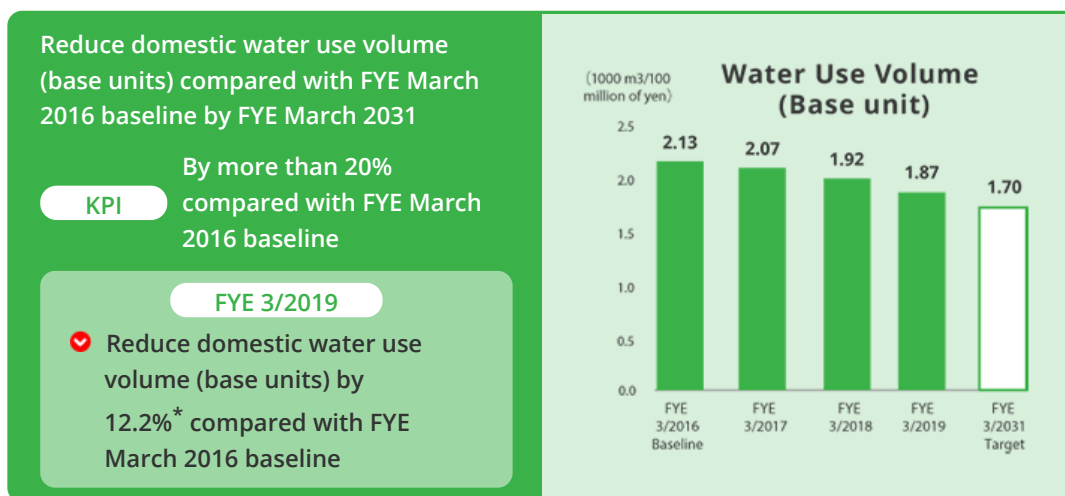

* excluding KM Biologics Co., Ltd.

Secure Water Resources

Appropriate Water Management and Water Risks

Water is a vital resource for the Meiji Group, and as an invaluable resource in the world, we believe its management is essential for achieving a sustainable society. Therefore, we set a target to reduce our water consumption by 20% (base unit, compared to FYE March 2016) by FYE March 2031. To achieve this target, we will appropriately manage water intake and discharge as well as mitigate risk, and thereby conserve water and ensure the continuity of our businesses.

Approach

Reduce Water Consumption via Appropriate Water Management and Water Conservation Equipment

We are constantly working hard to save water and reduce its footprint in the environment from our water intake. We have revised our production processes to enhance our water-use efficiency and are also working to recycle water.

Recycling Cooling Water for Reduced Water Usage

The Karuizawa plant operated by Food Segment produces cheese. For years, the plant had used well water in the heat exchangers used to cool cheese ingredients on the cheese production line. This

water was used only once, exiting the plant as wastewater. The plant installed chillers through which well water can be circulated and recycled. The new system yields a 16,000m³ annual reduction in water usage at the plant.



Chillers in Karuizawa plant

Reduced Water Consumption Through Greywater System

KM Biologics has installed greywater* recycling systems in four of its manufacturing buildings at its Kumamoto Production Center. These systems collect recyclable water for primary use from production facilities. This greywater is then used as makeup water in cooling towers. Water discharged from the cooling towers as secondary use water is first filtered and disinfected, and then used in toilets. Overall, approximately 30,000 m³ of water is recycled annually at the Kumamoto Production Center.

* Greywater: Non-potable water that is suitable for general and industrial use

Kumamoto Production Center greywater recycling system

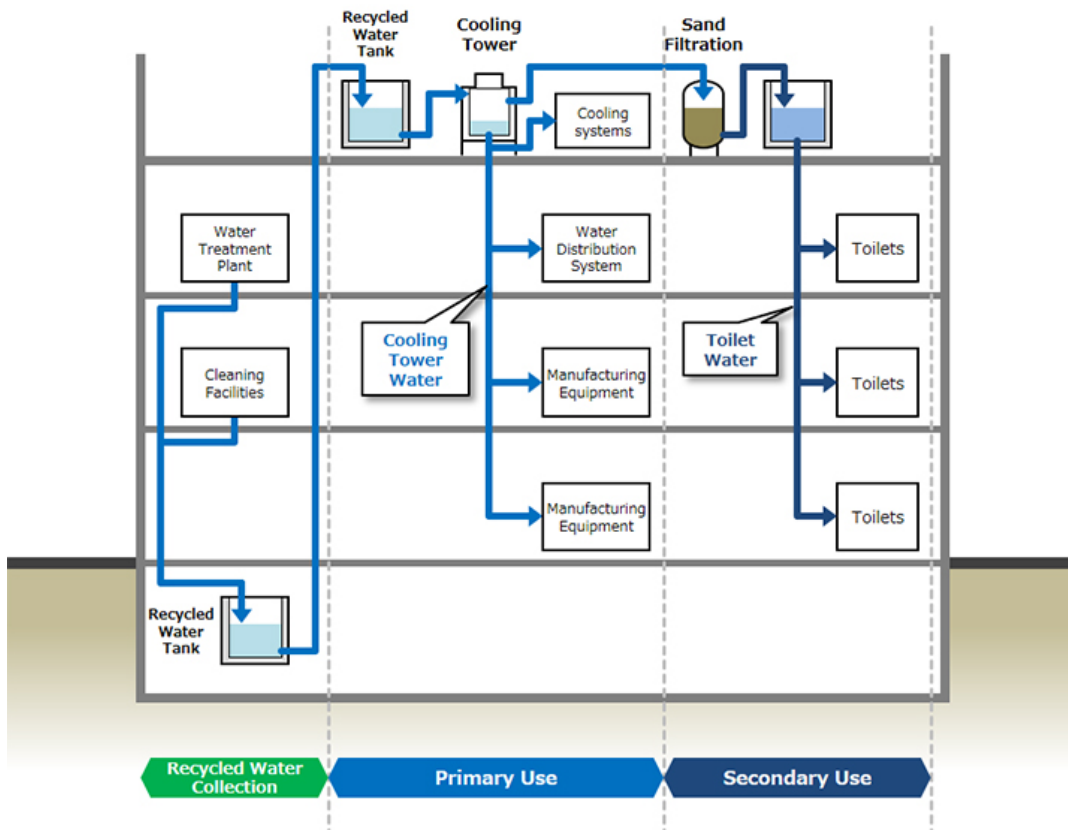

Paddy field flooding at KM Biologics Co., Ltd.

KM Biologics Co., Ltd. uses groundwater for production and waterlogs fields (saturate the soil with water) as part of a program to reduce the impact on the environment. We replenish and recharge the groundwater by diverting water from the Shirakawa River nearby and flood the fields with water for about 3 months before planting crops. We have been doing this since 2005 and have been recharging approximately 500 thousand tons of ground water annually, which is more than what is used at the head office and the Kumamoto Plant.



Improving Wastewater Quality Through Appropriate Chemical Substance Management

We have set more stringent standards for discharged water than the legal standards in Japan, and we are working on preventing water pollution. In order to reduce our environmental footprint of discharged water, we install equipment that uses activated sludge treatment and methane fermentation at plants or for processes that discharge a lot of water.



Methane fermentation process



Rainwater storage facility

Independent Practitioner's Assurance of Water Use Volume

In order to improve the reliability of the data, we obtained the independent practitioner's assurance for the domestic water use volume of FYE March 2019 indicated on p.43 in the Integrated Report 2019 by Deloitte Tohmatsu Sustainability Co., Ltd.

We work hard to improve the reliability of all environmental data.

- ▶ [Results of the Domestic Water Use Volume in FYE March 2019 \(PDF:788KB\)](#)
- ▶ [Independent Practitioner's Assurance Report \(PDF:198KB\)](#)

Survey of Water Risks

We assess the water risks in all areas where our domestic and international production sites are located in order to understand the impact of water usage on production. For this assessment, we use AQUEDUCT, an international water risk assessment software launched by the World Resources Institute (WRI). We also collect information and develop specific measures for the site.

Biodiversity

SDGs



Social Issues

Secure Local Biodiversity

KPI Conduct biodiversity activities at all domestic sites with production plants by fiscal year 2020

FYE 3/2019

- ✓ Food segment : 61% (27 sites / 44 sites)
- ✓ Pharmaceutical segment : 67% (4 sites / 6 sites)

Secure Local Biodiversity

Biodiversity Conservation

As the Meiji Group depends upon the bounty of nature, we undertake various environmental conservation activities. We promote biodiversity activities in consideration of local ecosystems at all sites inside and outside Japan that have production plants.

Approach

Promote Biodiversity Activities at all Domestic Sites with Production Plants

Environmental Communications

The Meiji Seika Pharma Gifu Plant provides environmental education for elementary school children. We explain our environmental conservation measures and give production plant tours highlighting our environmental facilities to enhance their understanding of environmental conservation.

- National Park
- Plant Trees
- Cleanup of Rivers or Coasts

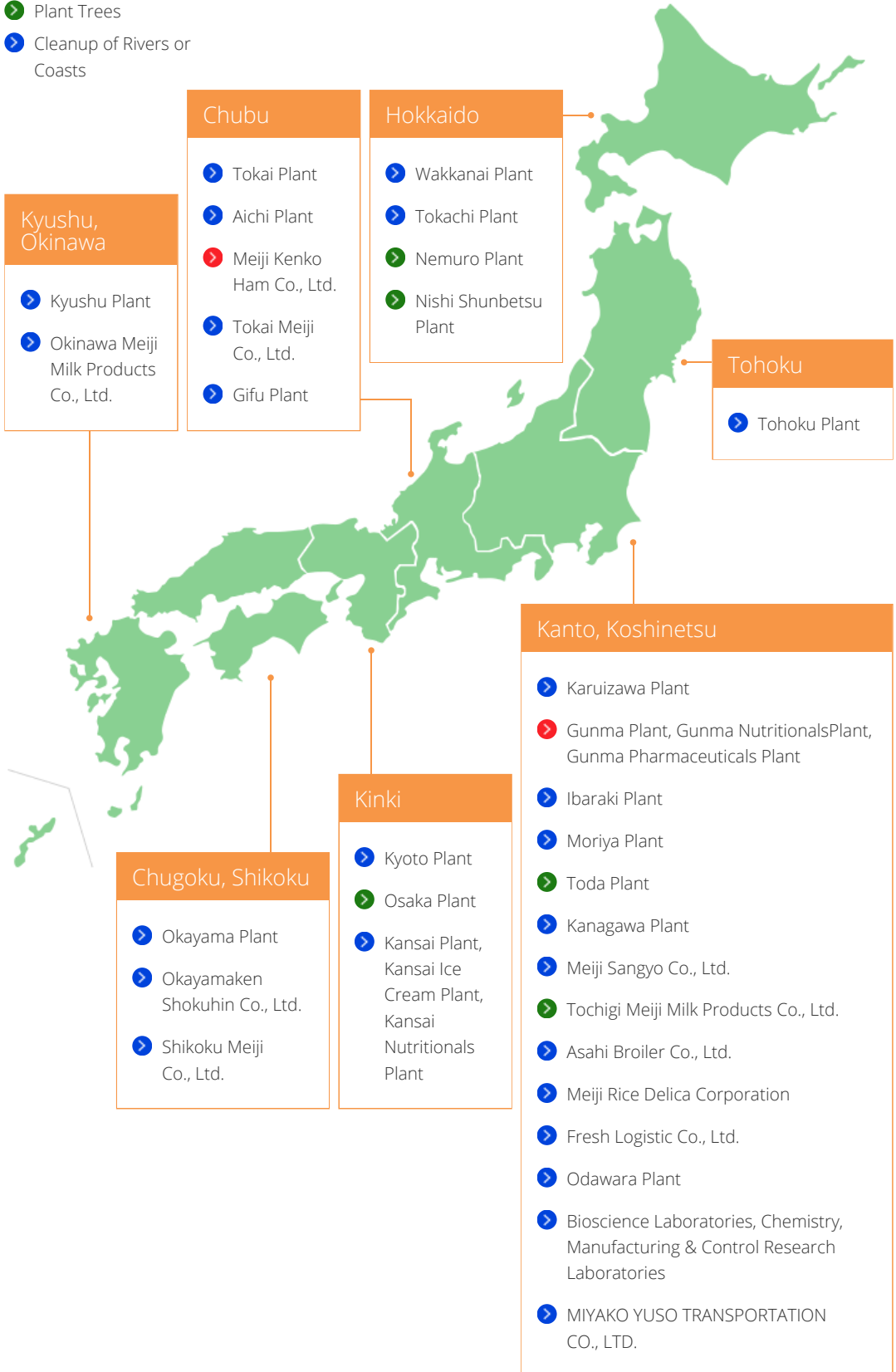

Conduct Biodiversity Activities at Overseas Sites with Plants

PT. Meiji Indonesia plants productive trees in water catchment areas on the mountain slopes around the Pasuruan regency.



We at Medreich celebrated the world environment day with purpose and to create more awareness on the environment. Across the locations environment protection related banners were displayed. Saplings were planted by employees to mark the importance of this very significant day. Posters were created, and employees were issued badges, environment tip cards. Employees were also encouraged to give environment related speeches to spread their knowledge on saving environments. Along with the above, Employees took Oath at every location for protecting Environment.



Biodiversity Conservation in the Nemuro Nature Conservation Area

Meiji concluded an agreement for the conservation of wild birds with the Wild Bird Society of Japan in 2007. Based on this accord, we jointly established a bird sanctuary in the Nemuro Nature Conservation Area, which we own (467ha) for nature restoration. This conservation area is located in Nemuro City, Hokkaido. Our employees provide volunteer work hours here to protect the environment, and the area is also used for the environmental education of local residents. The Nemuro Nature Conservation Area is host to *Grus japonensis*, *Himantopus himantopus himantopus*, *Haliaeetus albicilla albicilla*, *Haliaeetus pelagicus* and other endangered wild birds noted on the Red List*.

* Japan's Ministry of Environment evaluates the risk of extinction for various wild animals native to Japan. The ministry publishes a Red Data Book listing these animals and their circumstances, categorized by plant and animal species.

- State of Japan's Environment at a Glance: Extinct and Endangered Species Listed in the Red Data Book

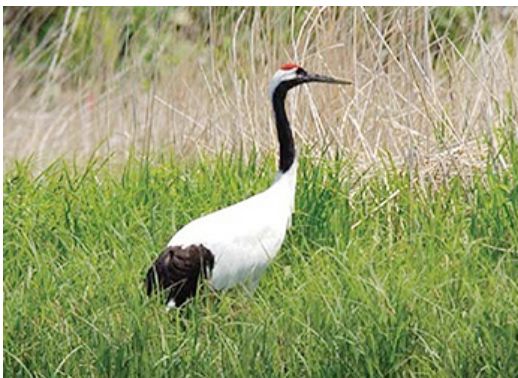

Grus japonensis



Haliaeetus albicilla albicilla



Himantopus himantopus himantopus



Haliaeetus pelagicus

A Richer Society

SDGs



We contribute to a richer society through communication and cooperation with stakeholders.

Human Resources



■ Social Issue

▶ Promote Diversity and Inclusion, and Provide Training to Employees

- ▶ Evaluation and Development of Personnel
- ▶ Diverse Employees
- ▶ Personnel Development

▶ Employee-Friendly Workplaces

- ▶ Encourage Personal Health Management
- ▶ Workstyle Reform
- ▶ Occupational Health and Safety

Society



■ Social Issue

▶ Respect and Promote Human Rights

- ▶ Human Rights Education and Training
- ▶ Initiatives Related to Human Rights Due Diligence

▶ Communicate with Stakeholders

- ▶ Improve Communications with Stakeholders
- ▶ Communicate with Our Customers

▶ Promote Social Contribution

- ▶ Promote Social Contribution

Human Resources

SDGs



Social Issues

- ▼ Promote Diversity and Inclusion, and Provide Training to Employees
- ▼ Employee-Friendly Workplaces

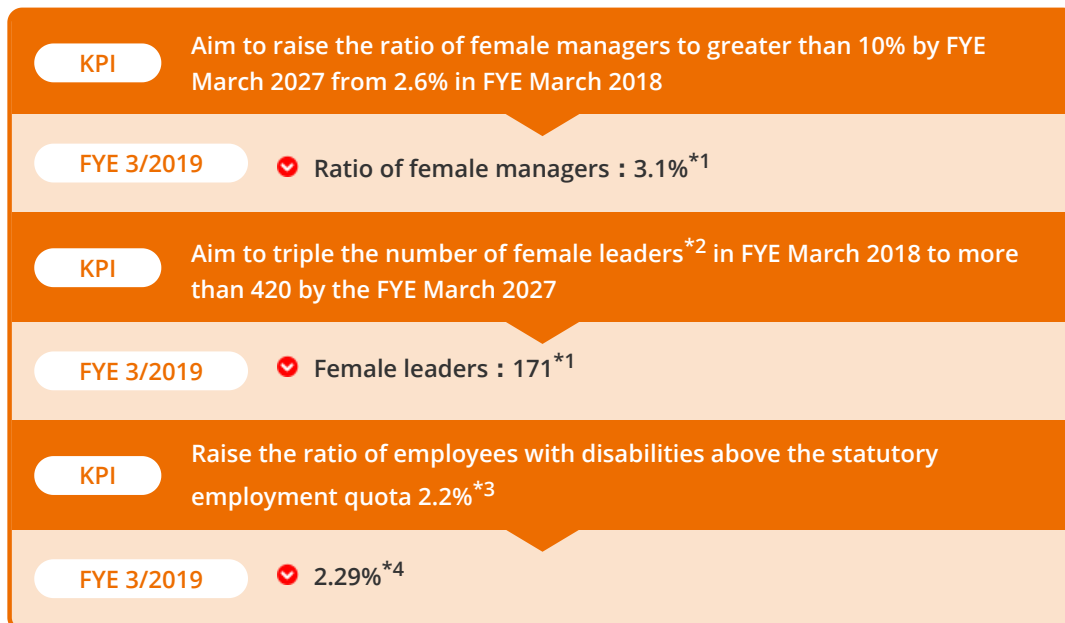

*1 Combined stand-alone numerical targets for Meiji Holdings Co., Ltd., Meiji Co., Ltd., Meiji Seika Pharma Co., Ltd. and KM Biologics Co., Ltd.

*2 Leader: Manager and assistant manager

*3 after April 1, 2018

*4 Combined stand-alone numerical targets for Meiji Holdings Co., Ltd., Meiji Co., Ltd., and Meiji Seika Pharma Co., Ltd.

Promote Diversity and Inclusion, and Provide Training to Employees

Approach to Human Resources

Our approach to human resources is to foster personnel who set innovative and ambitious goals for themselves, achieving these goals by drawing on their expertise and the group's strengths. In other words, our goal is to develop individuals who embody the Group Philosophy and the meiji way, practicing our Action Guidelines.

	FYE 3/2016		FYE 3/2017		FYE 3/2018		FYE 3/2019	
	Female	Male	Female	Male	Female	Male	Female	Male
Childcare leave								
Available until child is 2 years old	169	24	178	24	222	30	248	40
Measures for shorter working hours, etc., during childcare								
Available until child is in third grade of elementary school <ul style="list-style-type: none"> • Shorter working hours, beginning work earlier or later • Exemption from non-scheduled or night work, use of flextime system 	161	1	200	2	229	2	262	3
Percentage of employees returning to work after maternity or childcare leave (%)								
After maternity or childcare leave	100	-	100	-	100	-	100	-
Retention rate (%)								
Employees still working two months after returning to work	100	-	100	-	100	-	98	-

Support for Childrearing

Prenatal leave	Available immediately after becoming pregnant
Child-nursing leave	5 days per year available until child starts elementary school
Support for childrearing	When employee or spouse gives birth <ul style="list-style-type: none"> • Special payment for birth • Nursery items
Next-generation childrearing allowance	Available until employee's son or daughter reaches the age of 20
Benefit association	<ul style="list-style-type: none"> • Special payment for birth • 50% of amount used for babysitter services (not exceeding 30 days) • Special payment for school enrolment

[▶ Child Care Leave \(PDF:350KB\)](#)

Employment of Persons with Disabilities

We meet the statutory employment rate for people with disabilities. Moreover we create workplaces that allow employees to fully realize their capabilities regardless of disabilities. Our numerous employees with disabilities work at more than 40 bases around Japan.

Wheelchair ramps and barrier-free lavatories make it easier for people with disabilities to work for us.

[▶ Employees Rate for People with Disabilities \(PDF:350KB\)](#)

Retiree Reemployment

After reaching the retirement age of 60, our employees have the option of continuing to work up to the age of 65. Reemployed personnel guide and lead young employees, setting a good example. Since 2010, every applicant has been approved for reemployment.

[▶ Number of Seeking Reemployment \(PDF:350KB\)](#)

Personnel Development

The Meiji Group has created a basic policy concerning skills development, and the company provides a skills development structure to foster human resources.

<Basic policies for developing the capabilities of personnel>

To achieve the Long-term Vision laid out in the Meiji Group 2026 Vision, we will:

1. Develop personnel who have the proactive mindset, as well as the expertise, creativity, and practical skills, needed to take on and achieve ambitious targets
2. Spur group expansion by growing individuals and developing independent-minded personnel who raise groupwide capabilities
3. Develop personnel who fully understand the Group Philosophy and put the meiji way into practice at an advanced level

Skills Development Structure

	New employees	Mid-career employees	Managers	Objectives
Rank-based training	Training for new employees	Training for promoted employees Training for career track employees Training for clerical workers	Training for newly promoted managers	<ul style="list-style-type: none"> • Train young employees • Develop promoted employees • Develop management skills
Global training Diversity management		Global training <ul style="list-style-type: none"> • Language training • e-learning • Training through overseas assignments Support to create individual career paths for women	Training for managers with female subordinates	<ul style="list-style-type: none"> • Develop personnel to work overseas • Strengthen diversity management
Developing next-generation leaders		Training for next-generation leaders Training at business school and external venues <ul style="list-style-type: none"> • Management school • Interaction with and exposure to other industries • Developing managers 	Training for top management	<ul style="list-style-type: none"> • Fostering innovation • Developing next-generation leaders • Developing next-generation managers
Division-specific and group company training such as self-development	Division-specific training <ul style="list-style-type: none"> • R&D • Quality • Manufacturing technologies • Logistics • Sales • Marketing 	Training for Group company employees New employees Business management (fundamentals and practice) Self-development support e-learning, Open college, Distance learning, Video archives		<ul style="list-style-type: none"> • Raise the level of expertise specific to a division • Strengthen group companies • Self-development support

Approach

Manager Development

Directors, Audit & Supervisory Board members, and executive officers receive opportunities to better understand their roles and duties. This training includes legal responsibilities, corporate governance, compliance, and risk management. If necessary, these individuals are provided with information about Meiji Group businesses, organizations, financial status, and so on.

Outside directors and outside Audit & Supervisory Board members are given information about Meiji Group management strategy and the nature and status of the company's businesses. These individuals are provided opportunities to observe factories, research centers, and other facilities. Newly appointed executives receive necessary training from external organizations.

Rank-Specific Training, Business Skills Training at Each Career Stage

Systematic training for Meiji Group employees starts with new-employee training, where employees learn the basic knowledge, behavior, and attitudes they need for work at Meiji. Next, employees receive training in logical thinking, follow-through, team-leadership skills, and the qualities and capabilities of a business leader. Managers receive training at each relevant stage, helping them reflect on their management style and strengthening their ability to foster their subordinates.

Training for upper management is designed to enhance management skills to make the workplace more dynamic and to cultivate an awareness of self-reform as participants seek to become management leaders.

➤ [Employee Training Expenses \(PDF:350KB\)](#)

Training Program for the Development of Personnel Capable of Working Globally

We provide a wide variety of training programs to develop personnel capable of working globally.

1. Self-development language courses
2. Language training in English- and Chinese-speaking countries for effective language-learning and understanding of different cultures
3. Programs sending selected personnel to business language schools to acquire practical language skills
4. Programs to instill perseverance, understanding of diversity, and mental toughness by sending personnel overseas to gain first-hand experience in business customs under challenging conditions

Personal Development Training

We provide motivated employees with opportunities for personal development on an applied-for basis. This program supports employees who wish to develop their abilities.

Employee Self-Assessment System for Career Planning

Under our self-assessment system, employees meet with a superior once a year to talk about the volume and quality of their work, their aptitudes, career plans, and related topics. This meeting is an opportunity for employees to think about their work style and career path. For the company, this meeting is a chance to learn the employee's ideas and situation. Based on these meetings, the company considers ways to best use and foster individual employees.

Employee-Friendly Workplaces

Encourage Personal Health Management

Meiji Group Declaration on Health Management

The Declaration on Health Management is our statement of policy for managing employee health. This Pledge apply to domestic Meiji Group companies and their officers and employees.

Pledge of Health and Productivity Management

Mental and physical health are fundamental to our employees and their families in enriching employee lives and allowing them work to their full potential. Mental and physical health are also fundamental to the company to increase productivity and corporate value. We at the Meiji Group aim to be a comfortable place to work, fostering dynamic employees who are healthy in mind and body.

1. Employees mindfully manage their own health and the health of their families.
2. The company actively supports employees as they work to build on their health management capabilities.
3. The company endeavors to establish a workplace where employees can work in confidence, physically and mentally.

<Promotion system>

The Meiji Group promotes health management, mostly through the Health Management Promotion Committee, comprised of the company and its health insurance society.

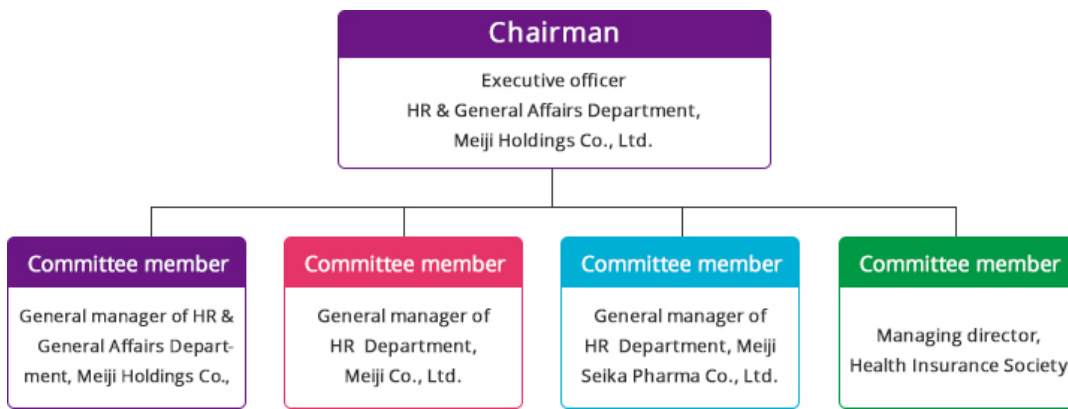

Approach

Promoting Employee Health

Promoting employee health is one of our corporate responsibilities. We create vibrant workplaces through multifaceted support for employee health.

Target

Item	Target
Fitness Habits, Incentive Sports	Improve the percentage of employees who participate and achieve the walking campaign
Smoking cessation promotion	Separation of smoking areas at the workplace Support for employees undergoing smoking cessation Step-by-step prohibit smoking during work hours
Employees with the Risk of Lifestyle-related Disease	Coverage* of employees undergoing second periodic health examinations is 100%

* Coverage: Health checks for employees by medical institution consultation and meeting with occupational physician, nursing staff and HR staff

Performance

		FYE 3/2016	FYE 3/2017	FYE 3/2018	FYE 3/2019
Fitness Habits, Incentive Sports					
Walking Campaign	Percentage of employees who participate (Participants / Employees)	49.3%	47.5%	49.5%	54.9%
	Percentage of employees who achieve (Achievers / Employees)	28.5%	28.3%	29.4%	30.8%
Percentage of employees who exercise for half an hour or more at least twice a week		22.1%	22.1%	22.2%	21.2%
Stress Checks					
Participation ratio		-	92.7%	94.6%	93.8%
Employees with the Risk of Lifestyle-related Disease					

	FYE 3/2016	FYE 3/2017	FYE 3/2018	FYE 3/2019
Fitness Habits, Incentive Sports				
Percentage of employees undergoing periodic health examinations	97.4%	99.6%	100.0%	100.0%

Topic

Fourth Straight Year as a Certified Health and Productivity Management Organization (White 500)

Our initiatives for employee health (checkups, health guidance, mental health care, exercise habit support, etc.) have won acclaim. Meiji Holdings, Meiji, and Meiji Seika Pharma were chosen for the list of Certified Health and Productivity Management Organizations (White 500).



Workstyle Reform

We believe it is our corporate responsibility to create a safe and healthy environment at the workplace. To achieve this, we are creating a positive and comfortable work environment to promote a good work-life balance.

Approach

Improving long working hours

- Reporting and managing working hours appropriately
- No-overtime days (once per week)
- Improving productivity by implementing a work-focus time strategy
- More effective meetings to increase productivity
- Streamlining work tasks at each workplace to improve efficiency

Encouraging employees to take paid leave

- Encourage employees to take paid leave for five consecutive days
- President advocates employees taking consecutive paid leave
- Schedule vacation at the beginning of the year and share it at work
- Follow up with employees who do not take paid leave

Promoting flexible work-style

- Implement work-at-home programs and flextime system
- Support male employees who wish to take childcare leave
- Run programs to help employees continue their jobs during life events
- Expand applicable time periods to work short shifts to accommodate childcare

[Overtime Work \(PDF:350KB\)](#)

Employee Awareness Survey

We periodically take an employee awareness survey. This survey assesses workplace climate and energy level from various angles, revealing employee perceptions and issues to be addressed.

Occupational Health and Safety

The Meiji Group embraces the concept of “safety over everything,” which is a theme in our Policy on Occupational Health and Safety. We work continuously to ensure workplace safety and promote

health maintenance and improvement among employees.

[Policy on Occupational Health and Safety](#)

Management system

Each company in the Meiji Group has the Health and Safety Committee. This committee takes the lead in setting yearly targets and following the PDCA cycle to take initiatives suited to the business and operating base.

Approach

Acquisition of ISO45001

Some plants have obtained the international certifications ISO45001.

Status of Acquisition of ISO45001

Moriya Plant

Sakado Plant

Kansai Plant

Kansai Ice Cream Plant

Kansai Nutritionals Plant

Meiji Ice Cream (Guang Zhou) Co., Ltd.

Reducing Equipment- and Work-Related Risks and Performing Safety Audits and Inspections

The Meiji Group works with partner companies to reduce equipment- and work-related risks, ultimately eliminating occupational accidents and injuries. We also perform safety audits and inspections to prevent occupational accidents, injuries, and legal and regulatory violations at each operating base. In the event an occupational accident or injury does occur, we investigate the cause, carry out equipment safety inspections and countermeasures, and work to prevent recurrence.

[Frequency Rate of Lost-worktime Injuries \(PDF:350KB\)](#)

Occupational Safety and Health Training at Each Business and Operating Base

The Meiji Group provides health and safety training suited to each business and operating base.

- Meiji Co., Ltd.

The company's Health and Safety Handbook covers laws, regulations, and the prevention of recurrence of past incidents. This book is used to train employees in occupational health and safety. Other training is designed to ensure that past incidents and lessons are not forgotten. This training is conducted at an internal training facility with panels displaying these incidents and lessons learned. The facility also provides and sensory equipment to experience safety.

- Meiji Seika Pharma Co., Ltd.

Each operating base conducts workplace patrols and hosts safety patrols performed by health and safety staff from other operating bases. External consultants perform safety assessments. All operating bases share these results, which are also used for the occupational health and safety training of employees.

Meiji Co., Ltd. and Meiji Seika Pharma Co., Ltd. share information beyond across outside their immediate organizations to prevent similar disasters.

Labor Relations

Meiji Co., Ltd., Meiji Seika Pharma Co., Ltd. and KM biologics Co., Ltd have labor unions.

We believe that sound labor-management relations are crucial for effective corporate management. We engage with unions in regular labor discussions, wage negotiations, and health and safety discussions.

Each union employs a union shop system, meaning 100 percent of full-time (non-management) employees join the union.

Society

SDGs



Social Issues

- ✔ Respect and Promote Human Rights
- ✔ Communicate with Stakeholders
- ✔ Promote Social Contribution

KPI

100% of new employees and those promoted to management positions employees* receive training on human rights

FYE 3/2019

✔ 100%

* For Meiji Holdings, Meiji, and Meiji Seika Pharma on a stand-alone basis

Respect and Promote Human Rights

Human Rights Education and Training

We engage in education and training activities related to respect for human rights and prohibition of discrimination, prohibition of forced and child labor, prohibition of harassment, safe and healthy workplaces, respect for fundamental rights of employees, and more, based on the Meiji Group Policy on Human Rights.

Approach

In-company Training

In Japan, we provide internal training related to general sustainability principles and human rights for new employees and those employees promoted to management positions in Meiji HD, Meiji, and Meiji Seika Pharma and employees of domestic group companies. Training is based on the Meiji Group Policy on Human Rights. We also conduct internal human rights training at overseas group companies.

Evidence

	FYE 3/2017	FYE 3/2018	FYE 3/2019
New employees	211	237	214
Employees promoted to management positions	164	194	158
Employees at domestic group companies	-	-	528

Human Rights Management System

The Meiji Group Human Rights Meeting

In FY2019, the Meiji Group launched an inter-organizational Group Human Rights Meeting to address a broad range of human rights issues concerning the overall Group. The meeting reviews issues prioritized in the risk assessment of each business and weighs specific preventive measures and mitigation strategies. Having regular meetings will raise awareness of human rights throughout the Group. We will also have a system in place to address various issues domestically and abroad.



Implementing Human Rights Due Diligence

The Meiji Group has adopted the United Nations Global Compact. We have also implemented human rights initiatives based on the Meiji Group Policy on Human Rights and encourage our employees and supply chain to follow suit. Before implementing the human rights due diligence, we finished identifying and assessing risks at each stage of the value chain for both the Food and Pharmaceutical segments as part of an ongoing risk management process in FY2018.

Evidence

Our human rights due diligence begin with measures related to the procurement of main raw materials:

Cocoa

Palm oil

Paper raw materials

Raw milk

➤ Policies

Communicate with Stakeholders

Improve Communications with Stakeholders

We take every opportunity and use every means to engage in communications with important Meiji Group stakeholders (our customers, employees, business partners, shareholders and investors, global environment, society). In this way, we answer the expectations of our stakeholders and fulfill our social responsibilities.

Approach

Communicate with Shareholders and Investors

We hold briefing meetings, IR events, and publish an informative IR website to keep our shareholders and investors up to date on the direction and strategies of the Meiji Group.

➤ IR Activities (PDF:350KB)

External Dialogues

We hold dialogues without outside experts, reflecting their opinions and recommendations in our vision, upcoming fiscal year plans, and business tactics.

Environmental Communication

Each plant and research laboratory conducts reporting seminars and study groups to highlight our environmental initiatives for local citizens, local governments, elementary schools, and middle schools. In addition to covering our initiatives for water and air pollution and CO₂ reduction, we also listen to feedback to incorporate into future activities.

Participation in Trade and Environmental Organizations

As of March 2019

Trade Organization	Activities	Role
Japan Dairy Association	Provide milk influencers and the people concerned with dairy farming and business with the information, which leads to the solution to common challenges of the dairy farming and business and to the value improvement of milk and dairy products.	Director
Japan Dairy Industry Association	Provide information related to milk and milk products; environmental measures, etc.	Vice-Chair
Japanese Association of Fermented Milks and Fermented Milk Drinks	Provide information related to hygiene and quality of probiotics; start and operate a consumer consultation desk, etc.	Vice-Chair
Japan Milk Fair Trade Conference	Fairness certification marks/guarantees; consumer awareness promotions, etc.	Vice Committee Chair
Japan Ice Cream Association	Provide information for improved hygiene and quality related to ice cream; environmental measures, etc.	Vice-Chair
All Nippon Kashi Association (ANKA)	Provide stable supply of raw materials for sweets; initiatives to expand demand for sweets; normalize business practices; environmental measures, etc.	Chair
Chocolate and Cocoa Association of Japan	Promotional activities to spread awareness and encourage consumption of chocolate and cocoa; initiatives related to raw materials; share results of information collection and surveys, etc.	Vice-Chair
Japan Chocolate Fair Trade Conference	Chocolate and Cocoa Association of Japan activities: 1) To increase the consumption of Chocolate and Cocoa in Japan. 2) Provide information about raw materials of Chocolate and Cocoa. 3) Collect information and investigate its substance about Chocolate & Cocoa and its distribution.	Vice-Chair
Japan Biscuit Fair Trade Conference	Draft and manage fair competition rules serving as voluntary rules to prevent unethical gifts and fraudulent labeling related to biscuits.	Vice Committee Chair
Japan Care Food Conference	Establish standards to encourage confidence in care foods; conduct promotional activities; contribute to the health of citizens; contribute to the healthy growth of the industry.	Vice-Chair

Trade Organization	Activities	Role
Fair Trade Council of the Ethical Pharmaceutical Drugs Marketing Industry	Promote awareness, offer consultations, and provide guidance for fair competition rules related to pharmaceutical drugs.	Director
Federation of Pharmaceutical Manufacturers' Associations of JAPAN	The Federation investigates and studies necessary matters for the development of the pharmaceutical industry, and collects, complies, and implements impartial suggestions provided by the industry. The Federation acts as the coordinator to assist in the healthy development of the pharmaceutical industry and strives to improve the overall quality of life of all citizens.	Director
Japan Pharmaceutical Manufacturers Association (JPMA)	JPMA has been contributing to advancing global healthcare through the development of innovative ethical drugs, facilitating sound development of the pharmaceutical industry through proactively establishing policies and recommendations in response to globalization and enhancing public understanding of pharmaceuticals.	Director
Japan Association of Vaccine Industries	JAVI aims to promote appropriate vaccination by sharing information on vaccines and vaccination to increase public awareness and allow users to understand the facts before receiving vaccination.	Director
Japan Association of Blood Preparations	JABP's goal is to contribute to public health and social welfare through the promotion of the blood plasma product industry by developing the safety, efficacy and quality of blood plasma products and ensuring their appropriate use by health care providers and the public.	Director
Japan Veterinary Products Association	Japan Veterinary Products Association (JVPA) is a public interest incorporated association for development, improvement and spread of pharmaceuticals, quasi-drugs and medical devices used for animals, aiming at contribution to the improvement of animal health.	Director

Meiji Group Participation in Industry Group Environmental Committees

As of March 2019

Japan Dairy Industry Association	Environmental Committee
All Nippon Kashi Association (ANKA)	Environmental Committee
Japan Frozen Food Association	Environmental Subcommittee
Japan Food Industry Association	Environmental Committee
Kanto Forestry and Fisheries Environment Council	

Participation in Recycling Industry Committees

Committee for Milk Container Environmental Issues	General Affairs Committee, Event Committee
Plastic Packaging Recycling Council	Planning Committee, 3R Promotion Special Committee

Communicate with Our Customers

Food Segment

Our Customer Service Center strives to ensure customer trust and satisfaction through prompt, honest, fair, and appropriate service. The center receives a wide range of inquiries regarding products and services. We use this customer feedback to develop new, and improve existing, products and services.

Approach

Customer Service Center

Our Customer Service Center uses a proprietary system to record and analyze customer feedback. The center strives to respond politely and provide useful information to allow customers ease of mind in using our products. The center also shares information with related departments to develop and improve products and services for greater customer satisfaction.

Evidence

Inquiries to the Customer Service Center by Subject (FYE March 2019)

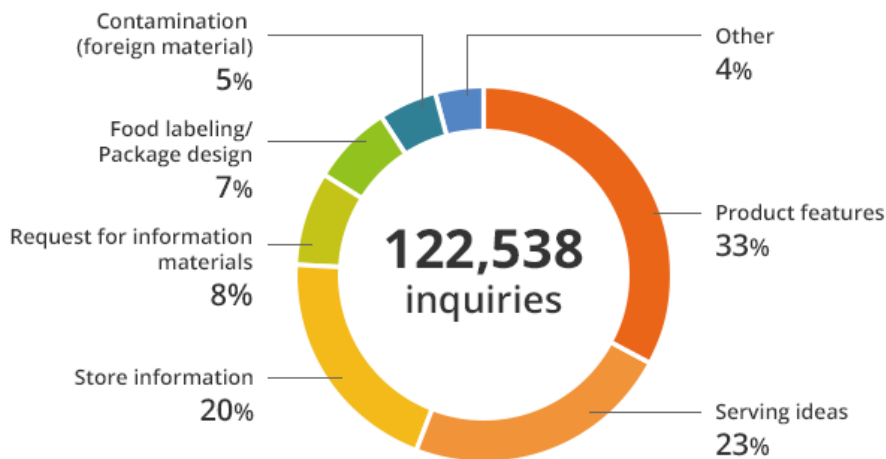

Topic

Reflecting Customer Feedback to Improve Products

<Products>Frozen Food, Meiji Pizza & Pizza (2PC)

<Customer Feedback> Exterior back label (how to consume) is confusing.

1. Label on the back says remove the frozen "pizza" from the interior bag. However, the interior bag is clear; I almost put it in my microwave.
2. Caution! label text is all in red, making it difficult to read. Hard to see which point is the real point of caution.

<After Improvement>

1. Modified explanation. Changed "interior bag" to "interior clear bag." Changed pull-out text next to the picture of the microwave to say, "remove from clear bag; do not wrap in plastic" (vs. "do not wrap in plastic" before change).
2. Caution! label now in black text, using red text for important points only.

<Exterior back (top)>

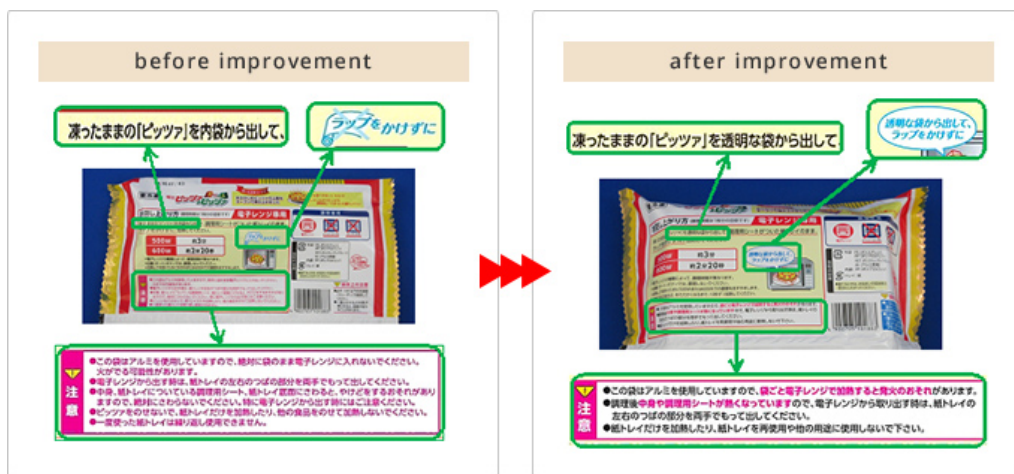

Counseling Office for New Mothers

Meiji's Counseling Office for New Mothers was established approximately 40 years ago. Managerial dietitians and dieticians at our counseling office offer valuable advice for new mothers, family members, and other persons engaged in childcare.

Evidence

Breakdown of Inquiries to the Counseling Office for New Mothers by Subject (FYE March 2019)

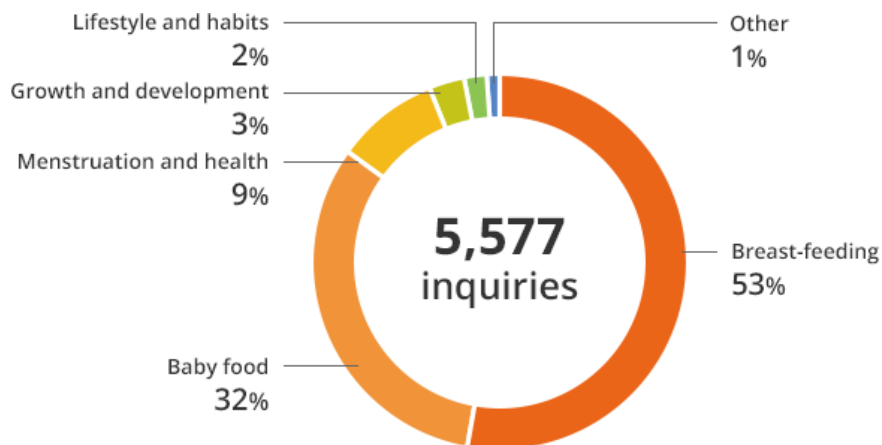

Adequate Labeling is for Customers Simple to Understand

The Meiji Group abides by the regulation and label products which is for customers simple to understand. The Meiji Group confirms the label on products adequate.



Red color	: Trademark Act
Orange color	: fair competition code (drinking milk)
Peach color	: FSC certified
Green color	: food labeling system, food labeling standards
Purple color	: Measurement Act
Olive	: Patent Act
Black	: Act on the Promotion of Effective Utilization of Resources
Aqua	: Product Liability Act

Pharmaceuticals Segment

Drug Information Center

We have developed a system to make best use of customer feedback in the Drug Information Center. We provide attentive and high-quality responses to healthcare professionals, patients, their families, and caregivers.

System for using customer feed back

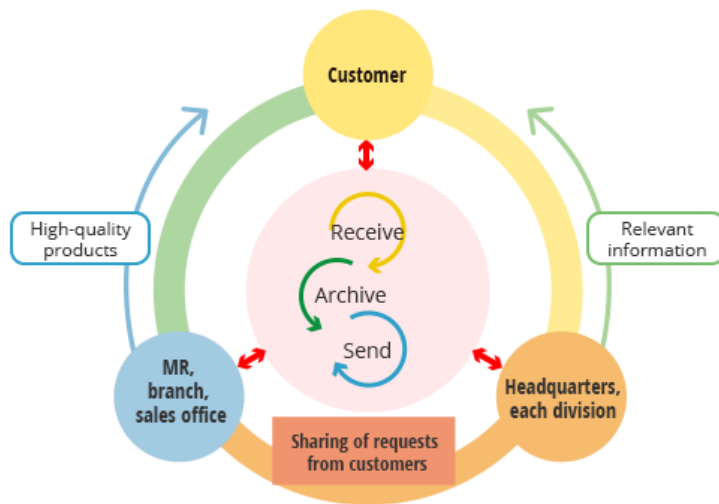

Evidence

Breakdown of Prescription Pharmaceutical Inquiries by Subject (FYE March 2019)

■ Meiji Seika Pharma Co., Ltd

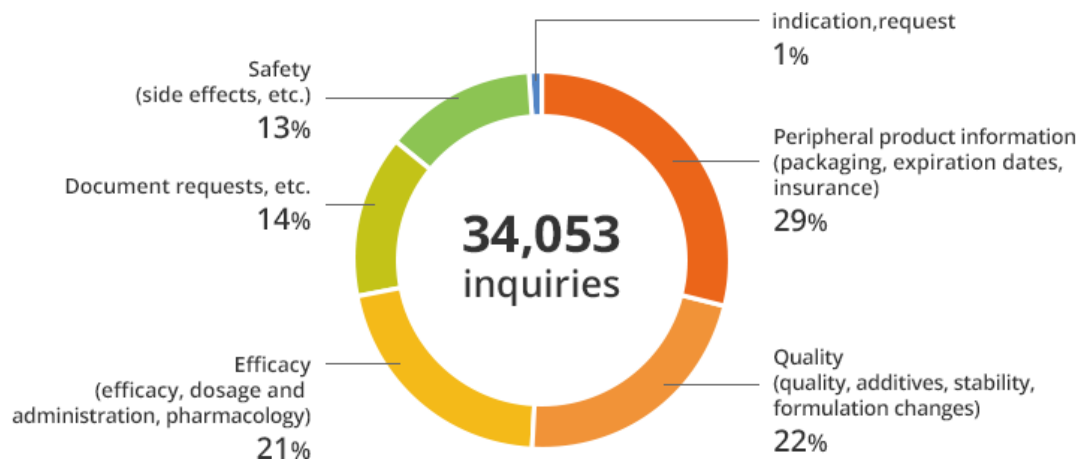

■ KM Biologics Co., Ltd

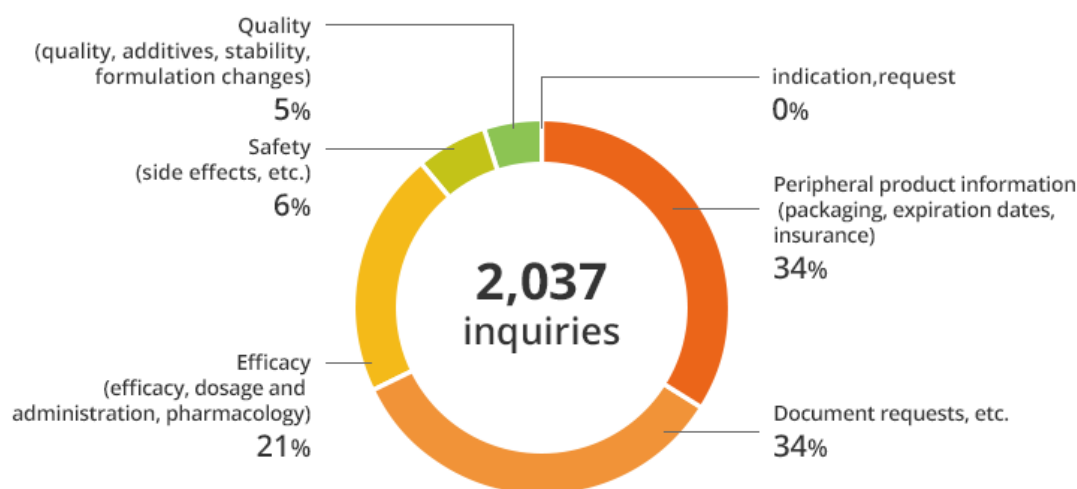

Topic

Improved aluminum sheet used for packing inhalation capsules

We incorporated patient feedback, changing the specification for cutting V-notches in the aluminum

sheet to improve usability.

We develop new products to ensure greater levels of customer satisfaction.

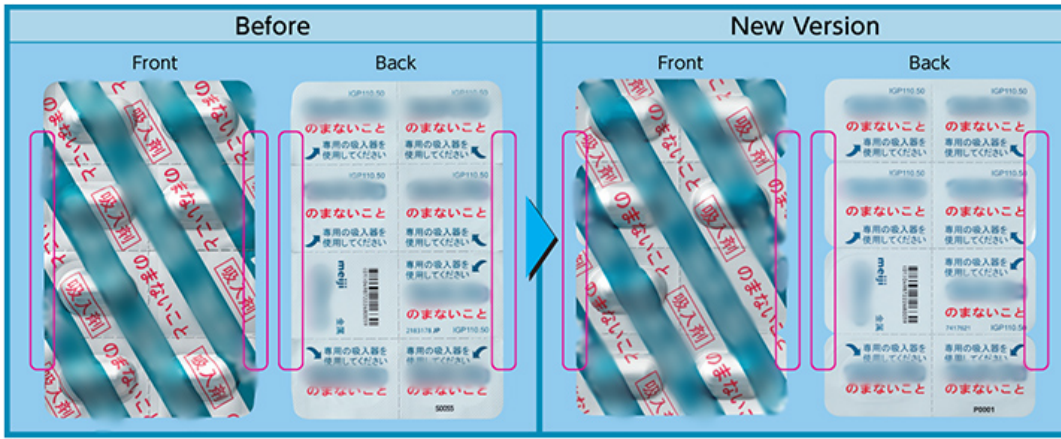

Initiatives for Appropriate Information Disclosure

The Meiji Group complies with laws and corporate ethics in advertising and promotion activities, providing information based on fairly stated content and phrasing to prevent falsehoods or exaggerations. We conduct activities report based on our Pledge to be a customer-oriented company.

Promote Social Contribution

Promote Social Contribution

As a member of society, the Meiji Group incorporates a variety of sustainability initiatives in our corporate behavior charter. We contribute to society by developing special infant formulas and drugs for rare diseases, as well as providing support for areas struck by disasters.

Approach

Social Contribution Activities in each Country, Region, Business Location

Participation in Local Cleanup Activities and Events

We are aware of our responsibilities as a good corporate citizen. Therefore, we regularly clean up and maintain the areas surrounding our facilities. Also, we actively participate in municipal authority activities and events aimed at beautifying local environments.



Topic

Shareholder Benefits

We offers a gift selection option for shareholder benefits. Shareholders have the option of donating an equivalent value of shareholder benefits to a charity organization, and the company matches this gift. In FYE March/2018, we donated a total of 12.04 million yen in chocolate, biscuits, and other items to 250 organizations (charities for Kumamoto Earthquake and Great East Japan Earthquake survivors, disabled children, etc.) through the Japan NPO Center.

Support for Disaster Areas, Developing Countries

We work in cooperation with NPO entities to provide support for recovery in the aftermath of the Great East Japan and Kumamoto Earthquakes.

Evidence

Disaster Area Support

The northeastern part of Japan was hit by a devastating earthquake on March 11, 2011, the Great East Japan Earthquake. In southern Japan, a strong earthquake centered in Kumamoto Prefecture in Kyushu occurred in the evening of April 14, 2016, followed by a second even stronger earthquake in the early morning of April 16, 2016. The Meiji Group gives donations, infant formula, confectioneries, and other items to those in disaster areas. Other support activities include holding such events as nutritional seminars to maintain the health of evacuees.

The Meiji Group participates in the support projects of the Reconstruction Agency. To support the restoration of the disaster areas of the Kumamoto Earthquake and the Great East Japan Earthquake, group companies held a market in the Meiji Group's head office building in January 2018. A total of 310 employees took part in the market in 2018. Volunteers cut grass around temporary houses and moved household valuables to safety near Mashiki, Kumamoto. Volunteers helped prepare and clean up after a memorial event in Morioka, Iwate. We provided nutrition education to a total of 162 citizens in devastated areas in seven different seminars during the year.



Social Contributions Through our Products

We contribute to Society through development and manufacture of rare diseases drugs, and manufacture and stable supply of special infant formula.

Topic

Rare Diseases Drug for Dravet's Syndrome Treatment, *DIACOMIT*®

Dravet's syndrome is an intractable form of epilepsy occurring in infancy. The disease develops in one infant in every 40,000. The syndrome is a severe disease that has a major impact on patients and their families because it causes seizures, delays physical and mental development, and has a high mortality rate.

As there was no effective drug for Dravet's syndrome treatment available, We launched *DIACOMIT*® Dry Syrup (oral suspension) and *DIACOMIT*® Capsule in 2012. We make efforts to provide accurate and timely information on the effectiveness and safety of this drug to healthcare professionals for the



correct dosage to patients. Patients, their families, healthcare practitioners, and the government have high expectations for *DIACOMIT*®, and they regularly express their gratitude to us for the drug.

Voices

Meiji Group's contribution for children with intractable diseases



Yushi Inoue, M.D.
Director of Hospital Shizuoka
Institute of Epilepsy and
Neurological Disorders
National Hospital Organization

A drug for the rare disease Dravet's syndrome, *DIACOMIT* has been prescribed to approximately 500 children since launch in 2012.

Covering all cases, we have collected high-quality post-marketing surveillance, a rarity for many drugs.

Enlightenment tools have been developed to enable information provision that benefits illness understanding and treatment. Recently, I have the impression that it has become less difficult to manage the severe seizures associated with this illness, which may be attributable to the popularity of *DIACOMIT*.

Special formulas are vital to the lives of children with intractable diseases. We are grateful that the company is responded to social needs by continuing to offer these products.

Raising Awareness of Photodynamic Therapy (PDT) *LASERPHYRIN*® for Injection

Photodynamic therapy (PDT) is a topical treatment that entails the injection of a photosensitizing agent and the use of low-power laser light to irradiate lesions. The photosensitizing agent has a high affinity with tumors, and the laser light causes tumor tissue degeneration or necrosis. PDT is a treatment method that does not affect normal tissue and mitigates the physical impact on patients. We promote the combination of PDT *LASERPHYRIN*® for Injection and laser equipment for PD laser and PD laser BT.



Photodynamic laser device

Photodynamic therapy (PDT) *LASERPHYRIN*® for Injection was approved for indications of early lung cancer and malignant brain tumor treatment. This treatment was approved for indications of recurrent/residual esophageal cancer in 2015. Prior to this, there was no established standard therapy, and prognoses for this recurrent/residual esophageal cancer were not encouraging. We will continue to contribute to the field of medicine, promoting PDT and providing a stable supply of the drug and laser equipment.

Special Infant Formula Helps Save Babies' Lives

We manufacture and sell special infant formulas for babies with a variety of metabolic disorders. Often, babies are born with congenital metabolism disorders (also known as inborn metabolism errors). These babies require special nutritional management using special formulas suited to their particular disorder. We are committed to the production and supply of these special formulas. We manufacture and supply 20 types of special formula for a variety of metabolic disorders. These products include



officially registered formulas, as well as formulas designed for treatment of non-congenital metabolic disorders.

Our lineup of special formulas (registered special formulas)

As a leading manufacturer of infant formulas, it is our responsibility to ensure the healthy development of babies. We will continue to utilize the technologies and expertise amassed through creation of our products to better fulfill this mission.

Infant Formulas for National Council of Homes for Infants

As a leading company in infant formulas, we wanted to help promote healthy growth of infants and toddlers, and therefore we started donating Meiji Hohoemi in June 2019 to infant homes and orphanages nationwide through the National Council of Homes for Infants. We donated Meiji Hohoemi.



Infant home, Tokyo Keimei Gakuen Nyuji-bu

Donation

We want our business activities to benefit society. Every year, we donate a portion of our Meiji Milk Chocolate sales during January and February to a program that improves child refugee nutrition through the UN Refugee Agency (UNHCR). Between 2009 and 2018, we donated approximately ¥67.3 million from sales.

We also support the activities of Japan Hospital Clowns Association, a nonprofit organization. This organization brings smiles to children fighting diseases, children's families, and others involved in the children's lives.

Donating to the Children's Future Support Fund

Poverty in children is a major social issue and it is said that 1 in 7 children under 17 years old lives in poverty (according to the Comprehensive Survey of Living Conditions conducted in 2016 by Ministry of Health, Labor and Welfare). The Cabinet Office earmarked measures against child poverty as a future investment. The office is collecting donations from companies and individuals and other resources under the Children's Future Support Fund and is also managing the Future Support Network Project to support groups and organizations nationwide that help provide academic support and food for children. The Meiji Group has pledged its support to this cause since 2017 and donates every year to the Children's Future Support Fund.



Sustainable Procurement

SDGs



Sustainable Procurement

Social Issues

- Procure Raw Materials With Consideration Toward Human Rights and the Environment
- Initiatives for Sustainable Procurement



* Meiji group in Japan excluding KM Biologics Co., Ltd.

Procure Raw Materials With Consideration Toward Human Rights and the Environment

Procurement of Cocoa

The stable procurement of high quality cocoa beans is an important issue for us as the global demand for cocoa expands. We implement procurement with consideration toward human rights and the environment, cooperating with suppliers in accordance with the Meiji Group Procurement Policy and the Cocoa Procurement Guideline.

Approach

Initiatives in Accordance With the Cocoa Procurement Guideline

Our cocoa procurement practices are mindful of human rights and the environment in keeping with the Meiji Group Procurement Policy and the Cocoa Procurement Guideline established in September 2018. These practices include legal and regulatory compliance in cocoa-producing countries and regions, securing a proper working environment respectful of human rights, maintaining ecosystems, partnering with the World Cocoa Foundation (WCF), and running Meiji Cocoa Support, our own farmer support program.

Improve the Traceability of Cocoa

We improve the traceability of cocoa through Meiji Cocoa Support, which is intended to improve the operating environment of cocoa farmers. We have expanded the program to eight nations: Republic of Ghana, Republic of Peru, Republic of Ecuador, Bolivarian Republic of Venezuela, The United Mexican States, Dominican Republic, Federative Republic of Brazil, and in 2017, the Socialist Republic of Vietnam.

Link

 [Bean to Bar / Farm to Bar](#)

Our result in FYE March 2019

A decrease in the usage of traceable cocoa by 10% year-on-year. Because of unachieved usage of chocolate.

Procurement of Palm Oil

Palm oil, taken from oil palm trees cultivated in the tropics, is widely used in food processing. We implement procurement with consideration toward human rights and the environment, cooperating with suppliers in accordance with the Meiji Group Procurement Policy and the Palm oil Procurement Guideline.

Approach

Initiative in Accordance With the Palm Oil Procurement Guideline

We formulated the Palm Oil Procurement Guideline in September 2018. We implement procurement in accordance with the Palm Oil Procurement Guideline.

Shift to 100% RSPO-Certified Palm Oil

Meiji Co., Ltd. joined the Roundtable on Sustainable Palm Oil (RSPO) in March 2016. We are aiming to shift to 100% RSPO-certified palm oil by the fiscal year 2023.

Link

 [RSPO \(Roundtable on Sustainable Palm Oil\)](#)

Our result in FYE March 2019

Shift to approximately 2% RSPO-certified palm oil.

Shift to approximately 10% RSPO-certified palm oil in the plan for FYE March 2020.

Procurement of Paper

Following the Meiji Group Procurement Policy and the Paper Procurement Guideline, we are working with our suppliers to procure paper raw materials for product and office use in ways that care for human rights and the environment.

* Meiji group in Japan excluding KM Biologics Co., Ltd.

Approach

Expand Use of Environmentally Friendly Paper Through the Paper Procurement Guideline

We formulated the Paper Procurement Guideline in September 2018. We implement procurement in accordance with the Paper Procurement Guideline. We are expanding the range of eco-friendly papers (including paper with FSC®* or other certifications and post-consumer paper) that we use for product containers, packaging, printing, and copying. By fiscal 2020, we aim to use only eco-friendly raw materials for paper.

Our result in FYE March 2019

Use 55.3%* of paper raw materials including paper with FSC® or other certifications and post-consumer paper.

* Product containers and packaging produced of Meiji group in Japan excluding KM Biologics Co., Ltd.

Topic

■ Various Products

We use eco-friendly FSC®-certified paper for products such as Meiji Oishii Gyunyu 900ml (a drinking milk product), chocolate snacks, Kinoko no Yama and Takenoko no Sato, Strawberry Chocolate and (SAVAS) MILK PROTEIN Fat 0. We are expanding the range of products.



■ Various Printings

We use eco-friendly FSC®-certified paper for company guidebooks and various reports.

* FSC®: The Forest Stewardship Council. An independent non-profit that operates an international forest certification system to spread responsible forest management around the world.

Link

 FSC®

■ Procurement of Raw Milk

We implement procurement with consideration toward human rights, environment and animal welfare, cooperating with suppliers in accordance with the Meiji Group Procurement Policy and the Raw Milk Procurement Guideline.

Approach

Initiative in Accordance With the Raw Milk Procurement Guideline

We formulated the Raw Milk Procurement Guideline in October 2019. We implement procurement in accordance with the Raw Milk Procurement Guideline.

■ Supplier Assessment

Our goal is to deliver safe and secure products. To this end, we follow the Meiji Group Procurement Policy to ensure the quality and safety of raw materials and packaging. We use a fair and transparent supplier selection process, and practice socially responsible procurement mindful of human rights, the environment, and other considerations. When beginning trade with a new partner, we confirm the raw material and packaging data provided by the supplier and perform

quality analysis. We survey and audit the supplier manufacturing plant's production and quality assurance system, production control system, and the supplier's fulfillment of social obligations, including human rights and the environment. Suppliers must meet rigorous planning standards set by each Meiji Group company. In addition, we work with suppliers to improve any problems.

Approach

Supplier Assessment in Accordance With the Meiji Group Procurement Policy

To strengthen our response to sustainability issues in the supply chain, we survey and check supplier consideration and initiatives with respect to human rights and the environment, based on the Meiji Group Procurement Policy.

Evidence

Companies audited in FYE March 2017 : 185 (primary suppliers in Japan)

Companies audited in FYE March 2018 : 98 (primary suppliers in Japan)

Companies audited in FYE March 2019 : 98 (primary suppliers in Japan)

Total : 381

Initiatives for Sustainable Procurement

Expanding Meiji Cocoa Support

The stable procurement of high quality cocoa beans is an important issue for us as the global demand for cocoa expands. The Meiji Group supports cocoa-producing nations and farmers through the Chocolate and Cocoa Association in Japan, World Cocoa Foundation, and SMS-ECOM. In 2006, we began our own Meiji Cocoa Support program and have been deepening partnerships with cocoa-producing nations.



Lessons at cocoa farm

Link

- [Chocolate and Cocoa Association of Japan](#)
- [World Cocoa Foundation](#)
- [SMS-ECOM](#)
- [Sustainability Video \(Meiji Cocoa Support\)](#)

Approach

Support Cocoa Farmers Through Meiji Cocoa Support

Since 2006, the Meiji Group has supported the sustainable production of cocoa, working to improve the operating environment of cocoa farmers. Our employees visit cultivation sites to speak directly with cocoa farmers and confirm local needs before determining a support plan. We conduct seminars on cultivation technology and insect-pest control and supply seedlings to increase yield. Additionally, we support community and infrastructure development by building wells, donating school supplies, and supporting environment-friendly farming practices. We teach our own fermentation technology to promote the production of high-quality cocoa, which in turn increases farmer income.

Link

- [Bean to Bar / Farm to Bar](#)

Expanding the Scope of Meiji Cocoa Support

Evidence

Scope of initiatives (fiscal 2017)

Eight countries

Republic of Ghana, The United Mexican States, Republic of Ecuador, Republic of Peru, Dominican Republic, Bolivarian Republic of Venezuela, Federative Republic of Brazil, Socialist Republic of Vietnam

In 2017, we established a cocoa farm equipment bank as a joint investment with a local enterprise in Peru. This resource is stocked with cocoa farm equipment that farmers can borrow. This system reduces work for the farmers and the burden of initial investment and maintenance costs for equipment, allowing farmers to concentrate on production with confidence.

Tackling Deforestation in our Cocoa Supply Chain

The governments of Côte d'Ivoire and Ghana and the world's leading cocoa and chocolate companies signed landmark agreements in November 2017 to end deforestation and promote forest restoration and protection in the cocoa supply chain.

This new public-private partnership – called the Cocoa & Forests Initiative (CFI) – has been organized by the World Cocoa Foundation (WCF), IDH - the Sustainable Trade Initiative, and the Prince of Wales's International Sustainability Unit (ISU). The Prince of Wales launched CFI in March 2017 in London. Thirty-three companies, accounting for about 85% of global cocoa usage, have joined CFI.

We implement an initial action plan from one part of Meiji Cocoa Support that spells out the specific actions it will take in 2018-2022 to deliver the commitments set out in the Framework. The Meiji's Cocoa & Forests Action Plan focuses on three pillars: forests protection and restoration; sustainable cocoa production and farmers' livelihoods; and community engagement and social inclusion.

- ▶ [2018-2019 Progress Report for Ghana \(PDF:3190KB\)](#)
- ▶ [Tracking Table for Ghana \(PDF:82KB\)](#)
- ▶ [Meiji's Initial Action Plan Narrative \(PDF:282KB\)](#)
- ▶ [Meiji's Initial Action Plans for Ghana \(PDF:161KB\)](#)

Link

- ▶ [Cocoa & Forests Initiative](#)

Drinking Milk Value Enhancement Campaign

The Current State of and Issues Facing the Japanese Dairy Business

Dairy farmers in Japan are aging and their numbers are decreasing. At the same time, dairy farming is hard work, and farms face a lack of successors. Drinking milk is an excellent food providing a convenient source of good quality protein and calcium; however, the diversification of drinking beverages is leading to a decline in the consumption of drinking milk.

Drinking Milk and Dairy Products Created Through Cooperation with Dairy Farmers

Raw milk, the raw material used to make drinking milk, is milked from healthy cows. The quantity and quality of raw milk is greatly influenced by temperature, humidity and feed. Our dairy managers work closely with local farmers and agricultural cooperatives to ensure stable access to high-quality raw milk. Hygiene is critical to the production of good-quality raw milk.

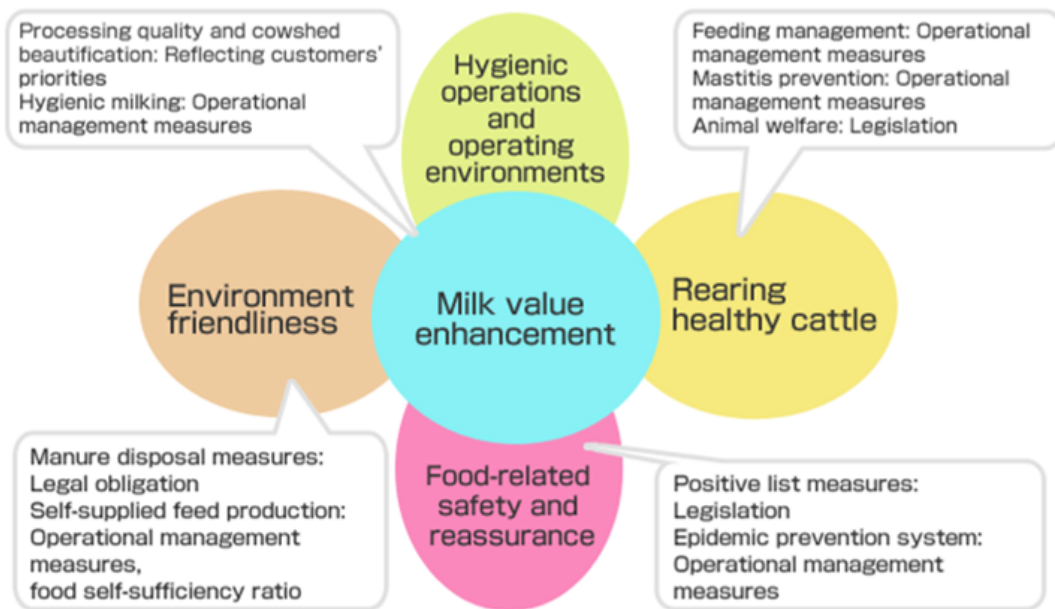

Approach

Partnership with Domestic Dairy Farmers to Ensure Stable Raw Milk Procurement

By closely working with dairy farmers, the Meiji Group is supporting stable and high quality milk production in order to deliver our customers delicious and quality milk.

Raw milk delivery and quality control

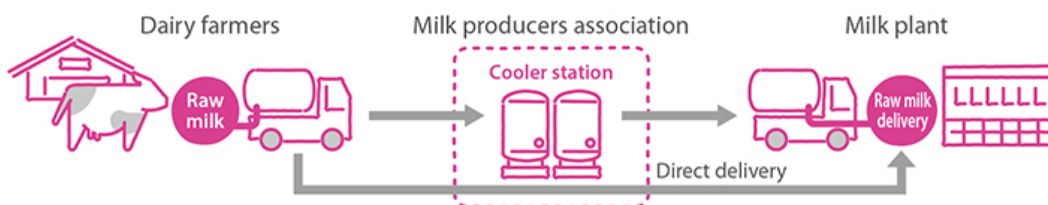

Initiatives for stable procurement of premium quality raw milk

Production sites

- Check feed and environment for breeding cows
- Hold seminars for the milk producers association on raw milk flavor

Receiving at plants

- Train taste testers and ensure thorough incoming inspections

Research laboratory

- Physical and chemical analysis of properties and ingredients for maintaining and improving quality
- Conduct taste assessment and disseminate information
- Technology development for more accurate and quicker inspections

Support dairy farmers using our unique operations support for producers

In domestic dairy farming, there are concerns about the raw milk production base weakening, and dairy farmers are having problems, such as a lack of labor force and/or training that labor force. To address these issues, the Meiji Group is currently pouring resources into the Meiji Dairy Advisory (MDA), which is our own farm management support program designed to help improve farms' productivity.

The goals of the MDA are to increase work efficiency and to



Discussion on production base support

improve work satisfaction for the employees. For management, the goals are to raise the productivity of the farm overall and to attract and secure good workers. To be more specific, the Meiji Group has assigned specialized advisory staff and is creating a system that provides continuous and various support. That support includes building a sense of ownership in each employee, reducing waste or loss on the farm and standardizing work processes or tasks. Thanks to the help of the Meiji Feed Co., Ltd., our Group company who is building a close relationship with producers nationwide, this MDA initiative will be developed even more. Accordingly, we hope to secure sustainable dairy production by improving work on farms and developing management skills.

Organic Drinking Milk

Meiji Organic Drinking Milk is certified organic under the Japan Agricultural Standards (JAS). This milk comes 100 percent from dairy cows in Hokkaido, conscientiously raised on organic feed. In 1999, we began working with dairy farmers belonging to the Organic Dairy Research Council in the town of Tsubetsu. In 2006, five farms were certified compliant with JAS for organic livestock. The number of certified dairy farms increased to eight in 2016. We supply new drinking milk value to our customers who are concerned with the environment and the health of dairy cows.



Stable Supply of Agricultural Chemicals and Veterinary Drugs

Our presence in agrochemicals and veterinary drugs contributes to the stable supply of safe and reliable agricultural, livestock, and marine products, as well as improves productivity around the world.

Approach

ORYZEMATE Protects Rice Plants From Rice Blast

ORYZEMATE prevents plant diseases by raising the disease resistance of rice and vegetables. This chemical helps farmers throughout Japan by contributing to the stable production of rice and vegetables.

Environmentally Friendly Herbicide ZAXA

We develop and sell environmentally friendly agricultural chemicals. ZAXA is a highly-effective long-lasting herbicide suitable for a variety of plants. The main constituent of ZAXA is a type of amino acid commonly found in nature. As a result, this herbicide has minimal effect on soil and is highly safe for livestock. The active ingredients in Meiji Eco Series pesticides and fungicides are also derived from natural sources. The leading product in this series, Harmomate Water-soluble Powders, meets Japan Agricultural Standards for use in organic cultivation.



R&D on New Agricultural Chemicals and Veterinary Drugs That Protect the Environment

Our research and development of agricultural chemicals and veterinary drugs produces groundbreaking products that are eco-friendly and very safe. These products additionally contribute to human prosperity by developing global agriculture and stabilizing food production.

Approach

R&D of Agricultural Chemicals

Afidopyropen / development code ME5343 (insecticide)

* Licensing agreement with BASF

Afidopyropen is highly effective against hard-to-control pests like aphids and whiteflies that attack soybeans and vegetables. The product is fast-acting, with sustained effectiveness and highly degradable in the environment. Afidopyropen is expected to be particularly safe for honeybees important pollinators in the habitat. BASF received the first registrations for this new insecticide in Australia, India and the U.S. in June 2018, and in Canada and China in 2019. BASF has submitted the regulatory dossier in Mexico and Argentina, with additional registration submissions planned in upcoming years for key markets worldwide. Afidopyropen was discovered by Meiji in collaboration with a research laboratory at the Kitasato Institute, supervised by a 2015 Nobel Prize laureate, Prof. Satoshi Omura. Following a licensing agreement between Meiji and BASF in May 2010, BASF is exclusively developing the product around the world, except for some regions/countries in Asia.

Link

 [BASF News Release](#)

Fenpicoxamide / development code ME5223 (fungicide)

* Joint development with Corteva Agrisciences

The product is an innovative drug in the fight against wheat leaf blight, which is highly resistant to agricultural chemicals. The effect is long-lasting and the product is highly degradable in the environment. This chemical has been registered as an agricultural chemical in Europe, a major market, in 2019.

Flupyrimin / development code ME5382 (insecticide)

* Joint development with UPL

Flupyrimin, a new insecticide discovered by Meiji, has been registered in Japan, and is currently under development overseas. Flupyrimin is effective against the major insect pests in rice, such as planthoppers and stem borers, including those populations resistant to existing insecticides. Furthermore, flupyrimin is a promising technology due to the low toxicity against honeybees, where there are few effective solutions due to growing concerns over the safety to pollinators. Paddy rice fields in India are the largest in the world (44 million hectares annually), and India accounts for around 21% of global rice production. In India, rice yields may be reduced by up to 45% due to insect pests and diseases. Stem borers and planthoppers notably affect over 30 million hectares of rice. Flupyrimin is an innovative solution that is effective in controlling both stem borers in early cultivation stages and planthoppers in mid-to-late stages with a single application. UPL submitted the regulatory dossier in India in 2019. Meiji and UPL will make further contributions to the development of agriculture in India and make people's lives better by introducing this innovative technology. We will keep up efforts to distribute this technology worldwide, continuing to deliver innovative environmentally friendly products.

Link

-  [Meiji and Arysta Enter into Licensing Agreement Concerning new Insecticide Flupyrimin in India \(PDF:48KB\)](#)
-  [R&D in Pharmaceutical Segment](#)

Governance



▶ Corporate Governance



▶ Compliance



▶ Risk Management

Compliance

In accordance with our Corporate Behavior Charter, we promote fair, transparent, and free competition. We conduct all transactions in compliance with the laws and regulations of the country in which business is done. We respect local cultures and customs and conform to our own in-company regulations. To further strengthen compliance, we work to improve training and increase compliance awareness throughout our organization.

Management System

Risk management and Compliance are closely interrelated. Accordingly, we have established a Compliance & Risk Management Committee within our Food segment. This committee, chaired by an officer appointed by the president, prepares and advances risk management action plans for our operating bases. For example, we conduct a compliance questionnaire annually, analyzing the results and identifying actions to take. Also, we conduct in-house activities to raise compliance awareness, including in-house training and a Compliance Improvement Month. We have established a Compliance & Risk Management Committee, chaired by the president, in our Pharmaceutical segment. The Pharmaceutical segment has Compliance Program Guidelines set in place which provides rules for fair business practices, including prohibiting bribes to government officials and other inappropriate acts.

Approach

Contact Information for the Compliance Counseling Desk

The Meiji Group provides contact information for our compliance counseling desk to respond to whistleblowing and provide consultation via various methods (including telephone, postal mail, e-mail, etc.). The Meiji Group outlines privacy protection in internal regulations to ensure that whistleblowers and people seeking consultation are not subjected to any unfair treatment.

Increase Compliance Awareness

Employees carry our Compliance Card, which includes the Corporate Behavior Charter and the contact details for our compliance counseling desk. The Meiji Group ensures strict adherence to the Corporate Behavior Charter. At the same time, the group cultivates and entrenches compliance awareness by enhancing in-house education and training and disseminating information through our intranet.



Compliance card carried by Meiji Group employees

An Ethical and Transparent Pharmaceuticals Company

Pharmaceuticals segment has established a Code of Practice for all officers and employees. As a pharmaceuticals company, Meiji Seika Pharma is committed to meeting society's expectations through the highest standards of ethics and transparency. The company promotes accountability through ongoing dialogue with associated researchers, healthcare practitioners, and patient

groups. Pharmaceuticals segment has also established Guidelines on Transparency of Relationships between Corporate Activities and Medical Institutions. Based on these guidelines, the company discloses details of the academic research grants it provides. These disclosures help illustrate the ways in which we contribute to progress in the life sciences, while adhering to the highest ethical standards.

Risk Management

Minimizing risk is important. As a corporate group operating in the food and health fields, it is our responsibility to ensure stable supply of pharmaceuticals, infant formulas, and enteral formulas, even in times of emergency.

Risk Management System

Meiji Group has risk management systems in place for our Food and Pharmaceutical segments. We conduct regular information sharing, identifying problems, and outlining resolutions.

Approach

Business Continuity Plans

We are in the process of further strengthening our business continuity plans. In the event of a major earthquake or other large-scale disaster, we aim to be able to restore operations as quickly as possible to continue supplying important foodstuffs and pharmaceuticals. We carry out ongoing disaster awareness measures, and conduct regular drills for our employee safety confirmation systems. We are also implementing improvements throughout the value chain. These improvements include establishing robust operational and infrastructural systems, earthquake-proofing facilities, increasing the number of production sites, decentralizing supply sources, and establishing IT system backups.

Basic Policies for Business Continuity Plans

To ensure are provided with the products and services they need, even in times of disaster, the Meiji Group will establish business continuity plans for three main purposes:

1. Ensure the lives and safety of persons and families involved in the group
2. Ensure the group continues to meet its social responsibilities
3. Minimize damage to our businesses that could arise from interrupted operations

Information Security

We have established a variety of information security policies and rules which aim to protect our intellectual property and strengthen the management of personal, confidential, and other sensitive information. We train employees thoroughly in information security, and we strive to remain abreast of advances in IT technology.

We are committed to providing stakeholders with all necessary information. Help desks and websites are available for customers at each of our businesses, and information is disclosed to shareholders and investors through investor relation activities and specialized websites.

Reducing Risk Associated with Social Networking Services

The Meiji Group has established various rules to reduce risk associated with social networking services. Moreover, we draw employee attention to such risks via an in-house portal site.

Privacy Protection

We appreciate the importance of customer privacy. We comply with relevant laws and standards for the protection of personal information, and we have established a Group Personal Information Protection Policy.

Link

[➤ Privacy Policy](#)

Intellectual Property

Intellectual property has grown increasingly important in recent years due to growing awareness of intellectual property issues in society and a variety of new government measures. We acquire intellectual property rights for the new products and technologies we research and develop. These rights make it possible for us to continue supplying customers with high added-value products.

Link

[➤ Business Risks](#)

Policies

Policies

The Meiji Group has established the following policies pursuant to the Meiji Group Corporate Behavior Charter.

Meiji Group Policy on Human Rights



The Meiji Group Philosophy includes our desire to offer a wide range of products and services vital to the daily lives of all people around the world. In so doing, we widen the world of Tastiness and Enjoyment, meeting all expectations regarding Health and Reassurance, striving to be a corporate group that is essential not to the lives of people in Japan, but also to the lifestyles of people all across the globe.

Our Corporate Behavior Charter includes respect for human rights. We recognize that all people are born free and with equal dignity and rights. We act fairly and faithfully to uphold this Policy on Human Rights in all our business activities.

We engage in the greater pursuit of initiatives related to human rights, striving to accomplish our duties in this respect.

1. Our Fundamental Position on Human Rights

We support and respect international rules related to human rights based on the Guiding Principles on Business and Human Rights. These rules include United Nations International Bill of Human Rights (based on the Universal Declaration of Human Rights, the International Covenant on Economic, Social and Cultural Rights, and the International Covenant on Civil and Political Rights), the core labour standards of the International Labour Organization (ILO) Declaration on Fundamental Principles and Rights at Work (defining basic human rights at work), the Ten(10) Principles of the UN Global Compact, the Organisation for Economic Co-operation and Development (OECD) Guidelines for Multinational Enterprises, the ethical principles of the Declaration of Helsinki, and the guidelines of the International Council for Harmonisation of Technical Requirements for Pharmaceuticals for Human Use (ICH).

As a member of the international community, Meiji Group respects fundamental human rights and seeks to avoid any complicity in the violation of human rights under any circumstances.

We comply with the laws and regulations of each country and region, respect local cultures, and have zero tolerance for discrimination based on ethnicity, gender, sexual orientation, gender identity, age, nationality, language, religion, disability, social origin, property, or any other personal status.

Further, we will not do any statements or acts that violate human rights, including sexual harassment, power harassment, etc.

We comply with the laws and regulations of each country and region. In the event of inconsistencies between international laws and local laws related to human rights, we comply with local laws while pursuing methods and means that incorporate the greatest respect to international laws.

This Policy complements the Meiji Group Corporate Behavior Charter, properly reflecting the spirit and intent of that policies and guidelines.

Under this Policy, we create individual procurement guidelines for materials having a potentially significant impact on human rights. In this way, we conduct materials procurement that is sensitive to human rights.

2. Applicable Scope

This Policy applies to all officers and employees of Meiji Group. Further, we ask all entities (“Partners”) in the value chain related to Meiji Group products and services to comply with this Policy.

3. Accomplishing Our Duty to Respect Human Rights

We strive to prevent violations of human rights in our organization. In the event we determine that our business activities have had a negative impact on human rights, we implement rational and appropriate measures to correct said violation, taking responsibility to accomplish our duty to respect human rights. We engage in the following initiatives to accomplish our duty in this respect.

- Human Rights Due Diligence

Meiji Group has established a Group Human Rights Meeting to identify and assess human rights risks in the value chain related to products and services offered by us. This meeting determines priority issues (risk-based approach), conducting its business in an orderly and steady manner. As necessary, the meeting establishes a subcommittee charged with preventing or alleviating any negative impact that Meiji Group has had on human rights in society.

- Executive Managing Officer

Under the orders of the president (chief executive officer) of Meiji Holdings Co., Ltd., the ultimate parent company of Meiji Group, the executive officer of the Sustainable Management Department, a supervisory department within Meiji Holdings, serves as the executive in charge of this Policy. The executive managing officer implements this Policy, appropriately collaborating with each president of our main operating companies, namely, Meiji Co., Ltd., Meiji Seika Pharma Co., Ltd. and KM Biologics Co., Ltd.

- Education, Training, and Communication

We incorporate this Policy into all aspects of our business activities, providing ongoing education and training related to human rights for officers and employees to ensure the effective implementation of this Policy. Further, we will communicate necessary information to our Partners.

- Responding to and Providing Relief in Connection With Claims

We operate an internal reporting system and respond to claims received, striving to prevent violations of human rights, detect any violations in the early stages, and prevent any recurrence. We provide relief as necessary through appropriate procedures.

- Information Disclosure

We provide timely disclosure of our progress and results related to human rights initiatives through our corporate websites and other means.

- Dialogues and Discussions

As we implement this Policy, we make frequent use of expertise and advice provided by outside, independent experts. In addition, we conduct serious dialogues and discussions with our stakeholders.

Established in April 2016
Amended in February 2020

 [Meiji Group Policy on Human Rights \(PDF:184KB\)](#)

Meiji Group Policy on Occupational Health and Safety

The Meiji Group's first priority is safety. With this in mind, we ensure workplace safety. We commit to help maintain and improve employees' health.

1. Legal and Regulatory Compliance

We comply with all laws and corporate rules related to occupational health and safety in the workplace.

2. Prevention of Work-Related Accidents

We identify and assess sources of danger in the workplace and reduce or eliminate risks to prevent work-related accidents.

3. Physical and Mental Health Maintenance

We provide safe, comfortable workplace environments and support employees' sound physical and mental health.

4. Health and Safety Education for Employees

We regularly offer in-house training on occupational health and safety as well as traffic accident prevention. We encourage employees to be aware of the importance of occupational health and safety.

Established in April 2017
Amended in February 2020

 [Meiji Group Policy on Occupational Health and Safety \(PDF:10KB\)](#)

Meiji Group Procurement Policy

We, Meiji Group, seek to provide our customers with high-quality, safe, and secure products. We commit to fair and transparent transactions and maintain compliance with all laws and regulations, working in cooperation with our partners to ensure that all procurement activities fulfill our social responsibilities, including those related to human rights and the environment.

1. Legal and Ethical Compliance

We comply with the laws and regulations of each country and region in which we operate and engage in fair, transparent, and proper procurement activities. We fulfill the terms of our contracts with partners in good faith and appropriately manage all confidential and personal information related to procurement transactions.

2. Product Quality and Safety

In our procurement activities, we place the highest priority on quality and safety in order to bring peace of mind to everyone who selects our products.

3. Fair and Transparent Selection of Suppliers

We commit to select suppliers in a fair and transparent manner. We evaluate potential suppliers based on product quality and safety, as well as price, delivery time, and their track record in providing stable supplies.

4. Protection of Human Rights and the Environment

In line with the Meiji Group Policy on Human Rights and the Meiji Group Environmental Policy, we integrate human rights and global environmental considerations in developing

and executing procurement activities.

5. Mutual Trust and Collaboration with Suppliers

We work to build cooperative, trusting relationships with suppliers, thereby striving to reduce procurement-related risks, and we pursue initiatives to be of benefit to the broader society.

6. Anti-Corruption

In line with the Meiji Group Anti-Corruption Policy, we prohibit the offering or receiving inappropriate benefits (money, gifts, entertainment, or other property benefits) exceeding a scope deemed proper according to social convention, striving to prevent corrupt practices.

Established in April 2016

Amended in February 2020

 [Meiji Group Procurement Policy \(PDF:14KB\)](#)

Cocoa Procurement Guideline

The Meiji Group procures cocoa according to the Meiji Procurement Policy, working with suppliers to engage in socially responsible activities (human rights, environment, etc.).

Scope of Application

Cocoa used in the production of consumer-use and industrial-use products

Principles for Action

1. We comply with the laws and regulations of cocoa-producing countries and regions, engaging in cocoa procurement via appropriate procedures.
2. We engage in sustainable cocoa procurement in accordance with the Meiji Group producer support program (Meiji Cocoa Support) and in cooperation with the World Cocoa Foundation.
 - a. Ensuring labor conditions are appropriate and respect human rights (monitoring for child labor, forced labor, etc.)
 - b. Ensuring the preservation of environmentally important areas (ecosystems, natural forests) in cocoa-producing regions
3. We notify suppliers that they are required to comply with the Cocoa Procurement Guideline. We take action as deemed necessary if we suspect suppliers of non-compliance.
4. We publish an annual report on our cocoa procurement activities.

Established in September 2019

Amended in February 2020

 [Cocoa Procurement Guideline \(PDF:11KB\)](#)

Palm Oil Procurement Guideline

The Meiji Group supports zero deforestation, and procures palm oil according to the Meiji Procurement Policy, working with suppliers to engage in socially responsible activities.

Scope of Application

Palm oil and palm kernel oil included in the sources of oils and fats used in the production of consumer-use and industrial-use products

Principles for Action

1. We give priority to the use of certified palm oil (RSPO, ISPO, MSPO, etc.).
2. . When using non-certified palm oil, Meiji (alone or in conjunction with third parties) selects palm oil recognized as being produced in a sustainable manner, according to a. through d., below:
 - a. Produced in compliance with laws and regulations of the country of production.
 - b. Produced under labor conditions that are appropriate and respect human rights (monitoring for child labor, forced labor, etc.)
 - c. Produced under conditions respecting the land rights of indigenous peoples and others.
 - d. Produced under conditions that preserve environmentally important areas (ecosystems, natural forests) in palm oil-producing regions.
3. We notify suppliers that they are required to comply with the Palm Oil Procurement Guideline. We take action as deemed necessary if we suspect suppliers of non-compliance.
4. We publish an annual report about palm oil usage and certified palm oil substitutes.

Established in September 2019

Amended in February 2020

 Palm Oil Procurement Guideline (PDF:13KB)

Paper Procurement Guideline

The Meiji Group supports zero deforestation, and procures paper according to the Meiji Procurement Policy, working with suppliers to engage in socially responsible activities.

Scope of Application

- Paper used in Meiji Group products and packaging
- Office paper, including photocopier paper, printed matter and product brochures

Principles for Action

1. We give priority to the use of environmentally friendly FSC^{*1}, PEFC^{*2}, and other forest certified and/or recycled paper.
2. When using non-certified/non-recycled paper, Meiji (alone or in conjunction with third parties) selects paper in compliance with a. through d. below:
 - a. All wood used is produced in compliance with laws and regulations of the country of production.
 - b. Laborers involved in cutting and harvesting labor under conditions that are appropriate and respect human rights.
 - c. Cutting and harvesting activities respect the land rights of indigenous peoples and others.
 - d. Produced under conditions that preserve environmentally important areas (ecosystems, peatlands, and natural forests) in production regions.
3. We notify suppliers that they are required to comply with the Paper Procurement Guideline. We take action as deemed necessary if we suspect suppliers of non-compliance.
4. We publish an annual report of our environmentally friendly paper usage and related initiatives.

*1 FSC (Forest Stewardship Council)

*2 PEFC (Programme for the Endorsement of Forest Certification Schemes)

Established in September 2019

Amended in February 2020

Raw Milk Procurement Guideline

The Meiji Group are working on procurement of raw milk according to Meiji Group Procurement Policy, cooperating with the suppliers to engage in socially responsible activities which include human rights, environment and animal welfare.

Scope of Application

Raw milk used in the production of consumer-use and industrial-use dairy products

Principles for Action

1. We comply with the laws and regulations of raw milk-producing countries and regions, and procure raw milk produced via appropriate procedures.
2. We contribute improvement in operating efficiency and managerial skill of the producers and engage in sustainable procurement of raw milk, in accordance with Meiji Group's own producer management support activity and in cooperation with such producers.
3. We believe that dairy cattle nurturing management conscious of "Five Freedoms" which are the guidelines regarding animal welfare, is both ethical and also applies to methods aimed at contributing to the development of the dairy industry. We promote combined business initiatives in cooperation with the relevant parties. That is to say, we make effort to contribute to feeding management, rearing healthy cattle, hygienic operations and operating environments.
4. We ensure that the suppliers know about this guideline, and take actions as deemed necessary if we suspect such suppliers of non-compliance.
5. We publish an annual report on our raw milk procurement activities.

Established in October 2019

Meiji Group Environmental Policy

Recognizing that our business operations originate from the bounty of nature, we, the Meiji Group, will contribute to the creation of a sustainable society. To this end, we intend to harmonize our business activities with the global environment and manage us in a way that protects the environment.

1. Compliance with Laws and Regulations

We comply strictly with environment-related laws, regulations and ordinances, stakeholder agreements, industry norms, and our voluntary standards.

2. Continuous Improvement of Environmental Conservation Activities

We improve our environmental conservation activities continually throughout our entire supply chain.

3. Reduction of Environmental Impact

- We pursue energy conservation toward a decarbonization, striving to reduce emissions of CO₂ and other greenhouse gases against climate change.
- We use water effectively and manage water quality appropriately, treating this valuable and limited resource with respect.

- We reduce waste, reuse resources, and encourage recycling throughout our product lifecycle in general and in all business activities, contributing to achieve a circular economy.

4. Biodiversity Conservation

We pursue biodiversity conservation by protecting ecosystems based on a global perspective in all our business activities.

5. Appropriate Information Disclosures

We engage with our stakeholders, providing timely and appropriate disclosures of environmental information.

Kazuo Kawamura

President and Representative Director

Meiji Holdings Co., Ltd.

Established in April 2011

Amended in September 2018

Amended in February 2020

 [Meiji Group Environmental Policy \(PDF:48KB\)](#)

Meiji Group Tax Policy

We, Meiji Group, comply with the tax laws and provisions of each country and region in which we operate. At the same time, we accomplish our social responsibility as a corporate citizen to pay taxes properly, contributing to economic and social development.

1. Tax Compliance

We comply with the tax laws, international agreements, social norms, and internal rules determined by each group company, etc., acting fairly and faithfully in accordance with high ethical standards.

2. Minimize Tax-Related Risks

To minimize tax-related risks, we strive to understand the tax laws and administrative systems in every country and region in which we operate, responding as appropriate.

3. Reduce Uncertainties

At times, group companies enter into business transactions for which the tax interpretation is not clear. In these cases, we investigate carefully any tax-related risks, seeking the advice of experts when necessary. In this way, we reduce uncertainties related to taxes.

4. International Mechanisms

We strive to comprehend the objectives behind OECD transfer pricing guidelines, mechanisms based on Base Erosion and Profit Shifting (BEPS), and various policies related to tax havens, responding to the tax systems and requirements the countries and regions in which we operate. In this way, we aim to ensure the transparency of our international business transactions.

5. Transfer Pricing

To ensure the appropriate allocation of profits among the countries and regions in which we operate, we conduct transactions appropriately with related overseas entities in consideration of arm's-length pricing.

6. Relationships With Tax Authorities

We cooperate with tax audits and tax administration in the countries and regions in which we operate, striving to maintain positive relationships with tax authorities.

Established in March 2019

Amended in February 2020

[Meiji Group Tax Policy \(PDF:14KB\)](#)

Meiji Group Anti-Corruption Policy

We, Meiji Group, engage in anti-corruption initiatives to remain a transparent, wholesome corporate group trusted by society, as defined in our Management Attitude.

1. Compliance With Laws and Regulations, etc.

We comply with the laws and regulations of each country and region in which we operate, as well as with group internal rules, to prevent corrupt practices. We also note the extraterritorial application of laws and regulations in countries and regions outside of Japan.

2. Prohibition Against Bribery, etc.

We prohibit, whether through direct or indirect means, the granting, proposing, or promising of bribes to government officials or equivalent persons, holding improper relationships with business partners or others, or engaging in relationships with antisocial forces.

We prohibit the offering or receiving of inappropriate money, gifts, entertainment, or other property benefits exceeding a scope deemed proper according to social convention.

3. Cooperation With Audits and Investigations

We provide full cooperation and appropriate responses to financial-related audits, etc. conducted by external financial statement auditors and group internal audit departments, as well as investigations conducted by relevant government authorities, etc.

4. Improvement of System

To prevent or detect corrupt practices as quickly as possible, we strive to improve a system for officers and employees to seek consultation or to submit notice of acts in violation of this policy or acts which may be in violation of this policy. We do not punish person seeking consultation or submitting notice in connection with its action.

5. Education and Training for Anti-Corruption

We provide appropriate education and training related to this policy and anti-bribery rules, etc. to officers, employees and business partners or others, striving to prevent corrupt practices.

6. Disciplinary Action, etc.

We take strict disciplinary action against officers or employees who violate this policy, in accordance with employment rules and other group internal rules. We also take appropriate measures against business partners or others who violate this policy.

Established in March 2019

Amended in February 2020

[Meiji Group Anti-Corruption Policy \(PDF:14KB\)](#)

Meiji Group Food Nutrition Labeling Policy

We, Meiji Group, recognize that people need correct and useful information provided clearly and simply. Our food nutrition labeling policy is designed to help people have clear information about our food products, to make right choices and to support health daily life.

1. Back of Pack Information

We provide nutrition information on back of pack on all of our food products in all markets worldwide. Nutrition information is provided as per serving/per portion and/or per 100

grams basis (depending upon local regulations) on the following key nutrients-energy (calories), protein, total carbohydrates, fat and salt.

Nutrition labels usually include the nutrient adequacy based on the official daily intake guidance where such guidance is available.

2. Front of Pack Information

We provide meaningful information fitting local needs on front of pack on our certain food products at a glance.

3. Nutrition Claims

If we make a claim about a healthy function or a nutrition for fortification purposes, we provide information on that nutrient on the label in accordance with local regulations or those set out by Codex for markets where regulatory standards have not been established.

Established in October 2019

Amended in February 2020

[📄 Meiji Group Food Nutrition Labeling Policy \(PDF:10KB\)](#)

Meiji Group Marketing Communication to Children Policy

We, Meiji Group, will engage in responsible marketing communication to children based on this Policy. This our Policy is global and applied to every market of confectionery and ice cream, hereinafter referred to as the “Products”, where we do business.

1. Our Fundamental Position

- As to the Products, we will engage in responsible advertising in any media primarily directed to children under the age of 12.
- We direct our advertising for the Products to gatekeepers (adults, parents, guardians), as well as people over the age of 12, whom we empower with information and product choices to make mindful snacking decisions.
- We prohibit all advertising, any type of commercial messaging and in-school marketing for the Products in primary and secondary schools (prior to university level).

2. Our policy

- We use best judgment to avoid programs and publications in connection with the Products, that are geared for or have high appeal to children under the age of 12. As “programs and publications” mentioned above, the following media is covered : radio, our own websites, DVDs/CDs/games, print media, mobile and SMS marketing, cinema, outdoor marketing, sponsorship and product placement in movies.
- Games and downloads will be geared to gatekeepers (adults, parents, guardians)/persons over the age of 12.
- We prohibit all in-school marketing for the Products in pre-school.
- We do not permit any branded communication for the Products in schools, including branded educational materials or equipment.
- As to the Products, all of communications on packaging and on in-store materials are directed to gatekeepers (adults, parents, guardians).
- We offer products that support, and promote the awareness of, healthy diets and food culture to support the healthy lifestyles.

3. Our food marketing standards

In addition to the foregoing and as to the Products, we, Meiji Group, share further guidance set forth below. These standards are consistent with and support the International

Chamber of Commerce (ICC) Code of Advertising and Marketing Communication Practice and the ICC Framework for Responsible Food and Beverage Communications, and ensure consistent, responsible depiction of food and lifestyle choices by the customers.

- We show proper serving and portion sizes, as well as consumption, in photography and imagery.
- We display nutrition information and serving sizes in recipes.
- We portray active and safe lifestyle choices.
- We clearly represent eating occasions.
- We reflect diversity of the consumers, in ethnicity, age and gender, as well as size and shape.
- We portray safe behaviors, including safe food handling and kitchen practices.

Disclosed in March 2020

 [Meiji Group Marketing Communication to Children Policy \(PDF:134KB\)](#)

Meiji Group Policy for the Marketing of Breast-Milk Substitutes (BMS Policy)

We, Meiji Group, commit to market our products ethically and are ensuring that our practices comply with laws and regulations of the countries where we do business. The purpose of this policy is to provide employees, distributors, and agents with appropriate guidance in the marketing of infant and follow-on formula ^{*1}:

1. Our Fundamental Position

- We acknowledge the importance of, and commits to the principles of, the WHO Code and subsequent relevant WHA resolutions.
- We support the WHO's global public health recommendation calling for exclusive breast-feeding for the first six months of life, followed by the introduction of safe and appropriate Complementary Foods thereafter.
- We encourage the importance of breast-feeding, alongside the introduction of safe and appropriate Complementary Foods after six months of age.

2. Our policy

- We are committed to ensuring that the practice of breast-feeding is not undermined through Marketing Material on any of our products.
- We will not advertise or promote Infant Formula in any country where we do business.
- We will not advertise or promote Follow-on Formula, in Higher Risk Countries ^{*2}.
- We support and advocate responsible Marketing practices that promote good health and safe nutrition for all infants and young children.
- We work with Partners, trade associations, industry groups and multiple stakeholders to promote responsible and ethical Marketing practices.
- We work with retail customers and Partners, acting on behalf of Meiji involved in bringing our products to the market to establish awareness and emphasize the importance of abiding by relevant laws, the WHO Code and this BMS Policy.
- We comply with all applicable local laws and regulations in the countries where we do business.
- We respect the role of national governments to develop health policies that are appropriate to their social and legislative frameworks.

*1 Follow-on Formula means, for the purpose of this BMS Policy, a formula product intended for, and marketed for, infants from six to twelve months of age.

*2 A list of Higher Risk Countries is included in Appendix A at the following website.

 https://research.ftserussell.com/products/downloads/F4G_BMS_Criteria.pdf

Disclosed in March 2020

 [Meiji Group Policy for the Marketing of Breast-Milk Substitutes \(BMS Policy\) \(PDF:49KB\)](#)

Pledge of Health and Productivity Management

The Company published its Pledge of Health and Productivity Management in April 2018. The Company aims to create a comfortable workplace for employees to be healthy and active, both physically and mentally. This pledge applies to domestic Meiji Group companies and their officers and employees.

Pledge of Health and Productivity Management



Mental and physical health are fundamental to our employees and their families in enriching employee lives and allowing them work to their full potential. Mental and physical health are also fundamental to the company to increase productivity and corporate value.

We at the Meiji Group aim to be a comfortable place to work, fostering dynamic employees who are healthy in mind and body.

1. Employees mindfully manage their own health and the health of their families.
 2. The company actively supports employees as they work to build their health management skills.
 3. The company endeavors to establish a workplace where employees can work in confidence, both physically and mentally.
-

Download Report

Download Integrated Reports

In September 2018, the Meiji Group issued our first integrated report, which will take the place of the annual reports published in prior years.

- [▶ Integrated Report](#)

Download Sustainability Reports

- [▶ Sustainability Report 2018 \(PDF:4082KB\)](#)
- [▶ Sustainability Report 2017 \(PDF:2183KB\)](#)
- [▶ Sustainability Report 2016 \(PDF:1551KB\)](#)
- [▶ Sustainability Report 2015 \(PDF:1195KB\)](#)
- [▶ Sustainability Report 2014 \(PDF:5938KB\)](#)

Collaborating With UN Agencies and Other Relevant Organizations

We collaborate with UN agencies and other relevant organizations.

The United Nations Global Compact

The Meiji Group signed on to the United Nations Global Compact in April 2019.

The UN Global Compact is a voluntary initiative in which businesses demonstrate creative leadership and act as upstanding members of society by participating in this global framework aimed at realizing sustainable growth. Our participation in the Global Compact is a way to clarify our corporate stance on the ten principles in four areas (human rights, labour standards, the environment and anti-corruption) outlined within the Global Compact.



The Ten Principles of the UN Global Compact

Human Rights

Principle 1: Businesses should support and respect the protection of internationally proclaimed human rights; and

Principle 2: make sure that they are not complicit in human rights abuses.

Labour

Principle 3: Businesses should uphold the freedom of association and the effective recognition of the right to collective bargaining;

Principle 4: the elimination of all forms of forced and compulsory labour;

Principle 5: the effective abolition of child labour; and

Principle 6: the elimination of discrimination in respect of employment and occupation.

Environment

Principle 7: Businesses should support a precautionary approach to environmental challenges;

Principle 8: undertake initiatives to promote greater environmental responsibility; and

Principle 9: encourage the development and diffusion of environmentally friendly technologies.

Anti-Corruption

Principle 10: Businesses should work against corruption in all its forms, including extortion and bribery.

The Meiji Group shall fulfill its contribution to the international community in accordance with the ten principles of the UN Global Compact.

■ The United Nations Global Compact

Sustainable Development Goals (SDGs)

The Meiji Group plans to contribute to the attainment of Sustainable Development Goals (SDGs) through various business activities and measures to fulfill its corporate social responsibilities.

SUSTAINABLE DEVELOPMENT GOALS



Collaborating With UN Agencies and Other Relevant Organizations

■ Stop TB Partnership

We supply kanamycin to tuberculous patients through the Stop TB Partnership

▶ Ensure the sustainable supply of pharmaceuticals

■ UNICEF

Medreich contributes to medicine accessibility through UNICEF

▶ Ensure the sustainable supply of pharmaceuticals

■ The Nutrition Japan Public Private Platform (NJPPP)

We contribute to nutrition improvement in emerging countries in partnership with NJPPP

▶ Improve nutrition in emerging countries

■ UNHCR (UN Refugee Agency)

We donate resources to a child refugee nutrition program through the offices of the UNHCR (UN Refugee Agency)

▶ Promote social contribution, Donation

ESG Data

Data of ESG (Environment, Society, and Governance) on Meiji Group's sustainability activities.

FYE 3/2019

▶ [ESG Data FY2018 \(PDF:350KB\)](#)
Last Updated: Jan 31, 2020

Standard Table

- [GRI Standard Table](#)
- [Sustainability Accounting Standard Board](#)

GRI Standard Table

This website is compiled with reference to the Global Reporting Initiative (GRI) Sustainability Reporting Standards.

GRI Standard Contents Index

Disclosure Number	Title	Reporting Requirements	Location and Notes
Organizational profile			
102-1	Name of the organization	a. Name of the organization.	<ul style="list-style-type: none"> Corporate Profile Corporate Profile Corporate Profile Corporate Profile Integrated Report 2019 P106 : Corporate Data
102-2	Activities, brands, products, and services	a. A description of the organization's activities. b. Primary brands, products, and services, including an explanation of any products or services that are banned in certain markets.	<ul style="list-style-type: none"> Our Business Products > Lineup Products > Worldwide Integrated Report 2019 P4-5 : Product and Market Presence Integrated Report 2019 P6-7 : History Consolidated Financial Results p5-7 : Below is an overview by segment. (PDF:603KB)
102-3	Location of headquarters	a. Location of the organization's headquarters.	<ul style="list-style-type: none"> Corporate Profile Integrated Report 2019 P106 : Corporate Data
102-4	Location of operations	a. Number of countries where the organization operates, and the names of countries where it has significant operations and/or that are relevant to the topics covered in the report.	<ul style="list-style-type: none"> Products > Meiji Worldwide Integrated Report 2019 P104-105 : Operating Bases and Group Companies
102-5	Ownership and legal form	a. Nature of ownership and legal form.	<ul style="list-style-type: none"> Corporate Profile Integrated Report 2019 P106 : Corporate Data

Disclosure Number	Title	Reporting Requirements	Location and Notes
Organizational profile			
102-6	Markets served	a. Markets served, including: <ol style="list-style-type: none"> i. geographic locations where products and services are offered; ii. sectors served; iii. types of customers and beneficiaries. 	<ul style="list-style-type: none"> ➤ Products > Worldwide ➤ Integrated Report 2019 P2-3 : At a Glance ➤ Consolidated Financial Results p5-7 : Below is an overview by segment. (PDF:603KB)
102-7	Scale of the organization	a. Scale of the organization, including: <ol style="list-style-type: none"> i. total number of employees; ii. total number of operations; iii. net sales (for private sector organizations) or net revenues (for public sector organizations); iv. total capitalization (for private sector organizations) broken down in terms of debt and equity; v. quantity of products or services provided. 	<ul style="list-style-type: none"> ➤ Corporate Profile ➤ Human Resources > Promote Diversity and Inclusion, and Provide Training to Employees > Diverse Employees > Number of Employees Overseas (Main Countries) ➤ ESG Data > Society ➤ Integrated Report 2019 P2-3 : At a Glance ➤ Integrated Report 2019 P66-73 : Consolidated Financial Statements ➤ Consolidated Financial Results p9-12 : Quarterly Consolidated Financial Statements (PDF:603KB)

Disclosure Number	Title	Reporting Requirements	Location and Notes
Organizational profile			
102-8	Information on employees and other workers	<p>a. Total number of employees by employment contract (permanent and temporary), by gender.</p> <p>b. Total number of employees by employment contract (permanent and temporary), by region.</p> <p>c. Total number of employees by employment type (full-time and part-time), by gender.</p> <p>d. Whether a significant portion of the organization's activities are performed by workers who are not employees. If applicable, a description of the nature and scale of work performed by workers who are not employees.</p> <p>e. Any significant variations in the numbers reported in Disclosures 102-8-a, 102-8-b, and 102-8-c (such as seasonal variations in the tourism or agricultural industries).</p> <p>f. An explanation of how the data have been compiled, including any assumptions made.</p>	<p>▶ ESG Data > Society</p>
102-9	Supply chain	<p>a. A description of the organization's supply chain, including its main elements as they relate to the organization's activities, primary brands, products, and services.</p>	<p>▶ Sustainable Procurement</p> <p>▶ Integrated Report 2019 P8-9 : Meiji Group's Process for Value Creation > Strengths and Features of the Meiji Group's Value Chain</p>

Disclosure Number	Title	Reporting Requirements	Location and Notes
Organizational profile			
102-10	Significant changes to the organization and its supply chain	a. Significant changes to the organization's size, structure, ownership, or supply chain, including: <ul style="list-style-type: none"> i. Changes in the location of, or changes in, operations, including facility openings, closings, and expansions; ii. Changes in the share capital structure and other capital formation, maintenance, and alteration operations (for private sector organizations); iii. Changes in the location of suppliers, the structure of the supply chain, or relationships with suppliers, including selection and termination. 	<ul style="list-style-type: none"> ➤ KM Biologics Co., Ltd. (PDF:85KB) ➤ Integrated Report 2019 P18 : Establishing the Co-Creation Center ➤ FYE 3/2020 2Q Earnings Release Presentation P16 > Closed Hokuriku Factory (PDF:1381KB)
102-11	Precautionary Principle or approach	a. Whether and how the organization applies the Precautionary Principle or approach.	<ul style="list-style-type: none"> ➤ Mission and Vision > Group Philosophy ➤ Risk Management ➤ Environmental Management ➤ Policies ➤ Appropriate Chemical Substance Management ➤ Integrated Report 2019 P42 : Caring for the Earth > Policies & Plan > Environmental Management System ➤ Integrated Report 2019 P59 : Risk Management
102-12	External initiatives	a. A list of externally-developed economic, environmental and social charters, principles, or other initiatives to which the organization subscribes, or which it endorses.	<ul style="list-style-type: none"> ➤ Sustainable Procurement > Procurement of Palm Oil > Shift to 100% RSPO-Certified Palm Oil ➤ Collaborating With UN Agencies and Other Relevant Organizations
102-13	Membership of associations	a. A list of the main memberships of industry or other associations, and national or international advocacy organizations.	<ul style="list-style-type: none"> ➤ Collaborating With UN Agencies and Other Relevant Organizations ➤ Society > Communicate with Stakeholders > Participation in Trade and Environmental Organizations
Strategy			

Disclosure Number	Statement from senior decision-maker	Reporting Requirements	Location and Notes
Organizational profile		a. A statement from the most senior decision-maker of the organization (such as CEO, chair, or equivalent senior position) about the relevance of sustainability to the organization and its strategy for addressing sustainability.	<ul style="list-style-type: none"> ➤ President's Message ➤ Integrated Report 2019 P16-21 : Message from the President
102-15	Key impacts, risks, and opportunities	a. A description of key impacts, risks, and opportunities.	<ul style="list-style-type: none"> ➤ Business Risks ➤ Risk Management ➤ Integrated Report 2019 P10-11 : Meiji Group's Approach to CSR in Our Value Chain ➤ Integrated Report 2019 P12-13 : Achieving Our Goals in 2026 Vision ➤ Integrated Report 2019 P59 : Risk Management
Ethics and integrity			
102-16	Values, principles, standards, and norms of behavior	a. A description of the organization's values, principles, standards, and norms of behavior.	<ul style="list-style-type: none"> ➤ Sustainability Management ➤ Mission and Vision ➤ Policies ➤ Integrated Report 2019 P1 : Group Philosophy ➤ Integrated Report 2019 P13 : The Meiji Group 2026 Vision ➤ Integrated Report 2019 P36 : The Meiji Group's Approach to CSR
102-17	Mechanisms for advice and concerns about ethics	a. A description of internal and external mechanisms for: <ul style="list-style-type: none"> i. seeking advice about ethical and lawful behavior, and organizational integrity; ii. reporting concerns about unethical or unlawful behavior, and organizational integrity. 	<ul style="list-style-type: none"> ➤ Compliance > Management System > Contact Information for the Compliance Counseling Desk ➤ ESG Data > Governance > Compliance ➤ Integrated Report 2019 P59 : Compliance
Governance			
102-18	Governance structure	a. Governance structure of the organization, including committees of the highest governance body. b. Committees responsible for decision-making on economic, environmental, and social topics.	<ul style="list-style-type: none"> ➤ Sustainability Management ➤ Integrated Report 2019 P37 : The Group CSR System ➤ Integrated Report 2019 P42 : Caring for the Earth > Environmental Mangement System

Disclosure Number	Title	Reporting Requirements	Location and Notes
Organizational profile			
102-19	Delegating authority	a. Process for delegating authority for economic, environmental, and social topics from the highest governance body to senior executives and other employees.	<ul style="list-style-type: none"> ➤ Sustainability Management ➤ Integrated Report 2019 P37 : The Group CSR System ➤ Integrated Report 2019 P42 : Caring for the Earth > Environmental Mangement System
102-20	Executive-level responsibility for economic, environmental, and social topics	<p>a. Whether the organization has appointed an executive-level position or positions with responsibility for economic, environmental, and social topics.</p> <p>b. Whether post holders report directly to the highest governance body.</p>	<ul style="list-style-type: none"> ➤ Sustainability Management ➤ Integrated Report 2019 P37 : The Group CSR System ➤ Integrated Report 2019 P42 : Caring for the Earth > Environmental Mangement System
102-21	Consulting stakeholders on economic, environmental, and social topics	Processes for consultation between stakeholders and the highest governance body on economic, environmental, and social topics. If consultation is delegated, describe to whom it is delegated and how the resulting feedback is provided to the highest governance body.	<ul style="list-style-type: none"> ➤ Sustainability Management ➤ Integrated Report 2019 P37 : The Group CSR System ➤ Integrated Report 2019 P42 : Caring for the Earth > Environmental Mangement System
102-22	Composition of the highest governance body and its committees	<p>a. Composition of the highest governance body and its committees by:</p> <ul style="list-style-type: none"> i. executive or non-executive; ii. independence; iii. tenure on the governance body; iv. number of each individual's other significant positions and commitments, and the nature of the commitments; v. gender; vi. membership of under-represented social groups; vii. competencies relating to economic, environmental, and social topics; viii. stakeholder representation. 	<ul style="list-style-type: none"> ➤ Corporate Governance ➤ ESG Data > Governance > Independence of Board of Directors ➤ Integrated Report 2019 p56 : Corporate Governance Data ➤ Corporate Governance Report p10 : II > 1. Organizational Composition and Operation

Disclosure Number	Title	Reporting Requirements	Location and Notes
Organizational profile			
102-23	Chair of the highest governance body	<p>a. Whether the chair of the highest governance body is also an executive officer in the organization.</p> <p>b. If the chair is also an executive officer, describe his or her function within the organization's management and the reasons for this arrangement.</p>	<p>➤ Corporate Governance</p> <p>➤ Integrated Report 2019 P56 : Corporate Governance Data</p>
102-24	Nominating and selecting the highest governance body	<p>a. Nomination and selection processes for the highest governance body and its committees.</p> <p>b. Criteria used for nominating and selecting highest governance body members, including whether and how:</p> <p>i. stakeholders (including shareholders) are involved;</p> <p>ii. diversity is considered;</p> <p>iii. independence is considered;</p> <p>iv. expertise and experience relating to economic, environmental, and social topics are considered.</p>	<p>➤ Corporate Governance</p> <p>➤ Integrated Report 2019 P56 : Corporate Governance Data</p>
102-25	Conflicts of interest	<p>a. Processes for the highest governance body to ensure conflicts of interest are avoided and managed.</p> <p>b. Whether conflicts of interest are disclosed to stakeholders, including, as a minimum:</p> <p>i. Cross-board membership;</p> <p>ii. Cross-shareholding with suppliers and other stakeholders;</p> <p>iii. Existence of controlling shareholder;</p> <p>iv. Related party disclosures.</p>	<p>➤ Corporate Governance</p> <p>➤ Corporate Governance Report p10 : II > 1. Organizational Composition and Operation</p> <p>➤ Corporate Governance Report p7 : I > 2. Capital Structure</p>

Disclosure Number	Title	Reporting Requirements	Location and Notes
Organizational profile			
102-26	Role of highest governance body in setting purpose, values, and strategy	a. Highest governance body's and senior executives' roles in the development, approval, and updating of the organization's purpose, value or mission statements, strategies, policies, and goals related to economic, environmental, and social topics.	<ul style="list-style-type: none"> ➤ Sustainability Management ➤ Corporate Governance Report p19 : II > 2. Matters on Functions of Business Execution, Auditing, Oversight, Nomination and Remuneration Decisions ➤ Corporate Governance Report p20 : II > 3. Reasons for Adoption of Current Corporate GovernanceSystem
102-27	Collective knowledge of highest governance body	a. Measures taken to develop and enhance the highest governance body's collective knowledge of economic, environmental, and social topics.	<ul style="list-style-type: none"> ➤ Corporate Governance Report p19 : II > 2. Matters on Functions of Business Execution, Auditing, Oversight, Nomination and Remuneration Decisions
102-28	Evaluating the highest governance body's performance	<p>a. Processes for evaluating the highest governance body's performance with respect to governance of economic, environmental, and social topics.</p> <p>b. Whether such evaluation is independent or not, and its frequency.</p> <p>c. Whether such evaluation is a self-assessment.</p> <p>d. Actions taken in response to evaluation of the highest governance body's performance with respect to governance of economic, environmental, and social topics, including, as a minimum, changes in membership and organizational practice.</p>	<ul style="list-style-type: none"> ➤ Corporate Governance Report p6 : 10. Supplementary Principle 4.11.3 Evaluation of the Board of Directors ➤ Integrated Report 2019 P58 : Evaluation of the Board of Directors

Disclosure Number	Title	Reporting Requirements	Location and Notes
Organizational profile			
102-29	Identifying and managing economic, environmental, and social impacts	<p>a. Highest governance body's role in identifying and managing economic, environmental, and social topics and their impacts, risks, and opportunities – including its role in the implementation of due diligence processes.</p> <p>b. Whether stakeholder consultation is used to support the highest governance body's identification and management of economic, environmental, and social topics and their impacts, risks, and opportunities.</p>	<ul style="list-style-type: none"> ➤ Sustainability Management ➤ Integrated Report 2019 P37 : The Group CSR System ➤ Integrated Report 2019 P42 : Caring for the Earth > Environmental Management System ➤ Integrated Report 2019 P59 : Risk Management ➤ Corporate Governance Report p25 : IV. Matters Related to the Internal Control System
102-30	Effectiveness of risk management processes	<p>a. Highest governance body's role in reviewing the effectiveness of the organization's risk management processes for economic, environmental, and social topics.</p>	<ul style="list-style-type: none"> ➤ Sustainability Management ➤ Risk management ➤ Integrated Report 2019 P56 : Corporate Governance ➤ Integrated Report 2019 P59 : Risk Management ➤ Corporate Governance Report p6 : 10. Supplementary Principle 4.11.3. Evaluation of the Board of the Directors ➤ Corporate Governance Report p25 : IV. Matters Related to the Internal Control System
102-31	Review of economic, environmental, and social topics	<p>a. Frequency of the highest governance body's review of economic, environmental, and social topics and their impacts, risks, and opportunities.</p>	<ul style="list-style-type: none"> ➤ Sustainability Management
102-32	Highest governance body's role in sustainability reporting	<p>a. The highest committee or position that formally reviews and approves the organization's sustainability report and ensures that all material topics are covered.</p>	<ul style="list-style-type: none"> ➤ Sustainability Management

Disclosure Number	Title	Reporting Requirements	Location and Notes
Organizational profile			
102-33	Communicating critical concerns	a. Process for communicating critical concerns to the highest governance body.	<ul style="list-style-type: none"> ➤ Sustainability Management ➤ Risk management ➤ Integrated Report 2019 P59 : Risk Management ➤ Corporate Governance Report P20 : IV > 2. Matters on Functions of Business Execution, Auditing, Oversight, Nomination and Remuneration Decisions
102-34	Nature and total number of critical concerns	<p>a. Total number and nature of critical concerns that were communicated to the highest governance body.</p> <p>b. Mechanism(s) used to address and resolve critical concerns.</p>	<ul style="list-style-type: none"> ➤ Sustainability Management
102-35	Remuneration policies	<p>a. Remuneration policies for the highest governance body and senior executives for the following types of remuneration:</p> <ul style="list-style-type: none"> i. Fixed pay and variable pay, including performance-based pay, equity-based pay, bonuses, and deferred or vested shares; ii. Sign-on bonuses or recruitment incentive payments; iii. Termination payments; iv. Clawbacks; v. Retirement benefits, including the difference between benefit schemes and contribution rates for the highest governance body, senior executives, and all other employees <p>b. How performance criteria in the remuneration policies relate to the highest governance body's and senior executives' objectives for economic, environmental, and social topics.</p>	<ul style="list-style-type: none"> ➤ Governance > Details of the Compensation of Directors and Audit & Supervisory Board Members ➤ ESG Data > Governance > Compensation of Directors Auditors ➤ Integrated Report 2019 P57 : Director Remuneration ➤ Corporate Governance Report p1 : I > 1. Basic Views > Disclosure Based on the Principles of the Corporate Governance Code ➤ Corporate Governance Report p16 : II > 1. Organizational Composition and Operation > Incentives / Director Remuneration

Disclosure Number	Title	Reporting Requirements	Location and Notes
Organizational profile			
102-36	Process for determining remuneration	<p>a. Process for determining remuneration.</p> <p>b. Whether remuneration consultants are involved in determining remuneration and whether they are independent of management.</p> <p>c. Any other relationships that the remuneration consultants have with the organization.</p>	<p>➤ Governance > Details of the Compensation of Directors and Audit & Supervisory Board Members</p> <p>➤ Integrated Report 2019 P57 : Director Remuneration</p> <p>➤ Corporate Governance Report p1 : I > 1. Basic Views > Disclosure Based on the Principles of the Corporate Governance Code</p>
102-37	Stakeholders' involvement in remuneration	<p>a. How stakeholders' views are sought and taken into account regarding remuneration.</p> <p>b. If applicable, the results of votes on remuneration policies and proposals.</p>	<p>➤ Corporate Governance Report p16 : II > 1. Organizational Composition and Operation > Incentives / Director Remuneration</p>
102-38	Annual total compensation ratio	<p>a. Ratio of the annual total compensation for the organization's highest-paid individual in each country of significant operations to the median annual total compensation for all employees (excluding the highest-paid individual) in the same country.</p>	Not Disclosed
102-39	Percentage increase in annual total compensation ratio	<p>a. Ratio of the percentage increase in annual total compensation for the organization's highest-paid individual in each country of significant operations to the median percentage increase in annual total compensation for all employees (excluding the highest-paid individual) in the same country.</p>	Not Disclosed
Stakeholder engagement			
102-40	List of stakeholder groups	<p>a. A list of stakeholder groups engaged by the organization.</p>	<p>➤ Society > Communicate with Stakeholders</p> <p>➤ Integrated Report 2019 P37 : Feedback from Experts</p>

Disclosure Number	Title	Reporting Requirements	Location and Notes
Organizational profile			
102-41	Collective bargaining agreements	a. Percentage of total employees covered by collective bargaining agreements.	<ul style="list-style-type: none"> ➤ Human Resources > Employee-friendly Workplaces > Labor Relations ➤ ESG Data > Society > Union participation rate
102-42	Identifying and selecting stakeholders	a. The basis for identifying and selecting stakeholders with whom to engage.	<ul style="list-style-type: none"> ➤ Society > Communicate with Stakeholders
102-43	Approach to stakeholder engagement	a. The organization's approach to stakeholder engagement, including frequency of engagement by type and by stakeholder group, and an indication of whether any of the engagement was undertaken specifically as part of the report preparation process.	<ul style="list-style-type: none"> ➤ Sustainability Management ➤ Society > Communicate with Stakeholders ➤ ESG Data > Governance > IR Activities for Institutional Investors and Analysts ➤ Integrated Report 2019 P30-35 : Working Toward Sustainable Cocoa Production ➤ Integrated Report 2019 P37 : Feedback from Experts ➤ Integrated Report 2019 P40 : Healthier Lives > Promoting Shokuiku Activities (Food and Nutrition Education) ➤ Corporate Governance Report p20 : III. Implementation of Measures for Shareholders and Other stakeholders
102-44	Key topics and concerns raised	a. Key topics and concerns that have been raised through stakeholder engagement, including: <ul style="list-style-type: none"> i. how the organization has responded to those key topics and concerns, including through its reporting; ii. the stakeholder groups that raised each of the key topics and concerns. 	<ul style="list-style-type: none"> ➤ Sustainability Management ➤ Society > Communicate with Stakeholders ➤ ESG Data > Governance > IR Activities for Institutional Investors and Analysts ➤ Integrated Report 2019 P30-35 : Working Toward Sustainable Cocoa Production ➤ Integrated Report 2019 P37 : Feedback from Experts ➤ Integrated Report 2019 P40 : Healthier Lives > Promoting Shokuiku Activities (Food and Nutrition Education) ➤ Corporate Governance Report p20 : III. Implementation of Measures for Shareholders and Other stakeholders
Reporting practice			

Disclosure Number	Title	Reporting Requirements	Location and Notes
Organizational profile			
102-45	Entities included in the consolidated financial statements	<p>a. A list of all entities included in the organization's consolidated financial statements or equivalent documents.</p> <p>b. Whether any entity included in the organization's consolidated financial statements or equivalent documents is not covered by the report.</p>	<p>➤ Integrated Report 2019 P104-105 : Operating Bases and Group Companies</p>
102-46	Defining report content and topic Boundaries	<p>a. An explanation of the process for defining the report content and the topic Boundaries.</p> <p>b. An explanation of how the organization has implemented the Reporting Principles for defining report content.</p>	<p>➤ Sustainability Management</p> <p>➤ Integrated Report 2019 P1: Contents > Editorial Policy</p>
102-47	List of material topics	<p>a. A list of the material topics identified in the process for defining report content.</p>	<p>➤ Sustainability Management > Meiji Group 2026 Vision > Outline of Vision</p> <p>➤ Integrated Report 2019 P36 : Outline of Vision</p>
102-48	Restatements of information	<p>a. The effect of any restatements of information given in previous reports, and the reasons for such restatements.</p>	Not Disclosed
102-49	Changes in reporting	<p>a. Significant changes from previous reporting periods in the list of material topics and topic Boundaries.</p>	Not Disclosed
102-50	Reporting period	<p>a. Reporting period for the information provided.</p>	<p>➤ Sustainability Management > Editorial Policy > Period Covered</p> <p>➤ Integrated Report 2019 P1 Contents : Using the "Integrated Report 2019"</p>
102-51	Date of most recent report	<p>a. If applicable, the date of the most recent previous report.</p>	Sustainability website : October, 2019
102-52	Reporting cycle	<p>a. Reporting cycle.</p>	Annual

Disclosure Number	Title	Reporting Requirements	Location and Notes
Organizational profile			
102-53	Contact point for questions regarding the report	a. The contact point for questions regarding the report or its contents.	▶ Contact Us
102-54	Claims of reporting in accordance with the GRI Standards	a. The claim made by the organization, if it has prepared a report in accordance with the GRI Standards, either: <ul style="list-style-type: none"> i. 'This report has been prepared in accordance with the GRI Standards: Core option'; ii. 'This report has been prepared in accordance with the GRI Standards: Comprehensive option'. 	Not Disclosed
102-55	GRI content index	a. The GRI content index, which specifies each of the GRI Standards used and lists all disclosures included in the report. b. For each disclosure, the content index shall include: <ul style="list-style-type: none"> i. the number of the disclosure (for disclosures covered by the GRI Standards); ii. the page number(s) or URL(s) where the information can be found, either within the report or in other published materials; iii. if applicable, and where permitted, the reason(s) for omission when a required disclosure cannot be made. 	▶ GRI Standard Table

Disclosure Number	Title	Reporting Requirements	Location and Notes
Organizational profile			
102-56	External assurance	<p>a. A description of the organization's policy and current practice with regard to seeking external assurance for the report.</p> <p>b. If the report has been externally assured:</p> <p>i. A reference to the external assurance report, statements, or opinions. If not included in the assurance report accompanying the sustainability report, a description of what has and what has not been assured and on what basis, including the assurance standards used, the level of assurance obtained, and any limitations of the assurance process;</p> <p>ii. The relationship between the organization and the assurance provider;</p> <p>iii. Whether and how the highest governance body or senior executives are involved in seeking external assurance for the organization's sustainability report.</p>	<ul style="list-style-type: none"> ➤ ESG Data > Environment > Environmental Management > Third-party certification ➤ ESG Data > Society > Accreditation in animal testing ➤ Integrated Report 2019 P107 : Independent Practitioner's Assurance of CO₂ emission Volume & Water Consumption Volume

103: Management Approach

103: Management Approach

103-1	Explanation of the material topic and its Boundary	<p>a. An explanation of why the topic is material.</p> <p>b. The Boundary for the material topic, which includes a description of:</p> <ul style="list-style-type: none">i. where the impacts occur;ii. the organization's involvement with the impacts. For example, whether the organization has caused or contributed to the impacts, or is directly linked to the impacts through its business relationships. <p>c. Any specific limitation regarding the topic Boundary.</p>	<ul style="list-style-type: none">➤ Sustainability Management > Materiality and KPIs➤ President's Message➤ Integrated Report 2019 P16-21 : Message from the President➤ Integrated Report 2019 P36 : Outline of Vision➤ Corporate Governance Report p22 : III. Implementation of Measures for Shareholders and Other stakeholders > 3. Measures to Ensure Due Respect for Stakeholders > Other
-------	--	--	--

103: Management Approach

<p>103-2</p>	<p>The management approach and its components</p>	<p>a. An explanation of how the organization manages the topic.</p> <p>b. A statement of the purpose of the management approach.</p> <p>c. A description of the following, if the management approach includes that component:</p> <ul style="list-style-type: none"> i. Policies ii. Commitments iii. Goals and targets iv. Responsibilities v. Resources vi. Grievance mechanisms vii. Specific actions, such as processes, projects, programs and initiatives 	<ul style="list-style-type: none"> ➤ Sustainability Management > Materiality and KPIs ➤ Risk Management ➤ Meiji Group 2026 Vision ➤ Policies ➤ President's Message ➤ Health and Nutrition ➤ Quality and Safety ➤ Climate Change ➤ Circular Economy ➤ Water ➤ Biodiversity ➤ Human Resources ➤ Society ➤ Sustainable Procurement ➤ Pharmaceuticals > Our Approach to Reliability Assurance ➤ Compliance > Management System > Contact Information for the Compliance Counseling Desk ➤ Integrated Report 2019 P12-13 : Achieving Our Goals in 2026 Vision ➤ Integrated Report 2019 P16-21 : Message from the President ➤ Integrated Report 2019 P36 : Meiji Group's Approach to CSR > Meiji Group CSR 2026 Vision ➤ Integrated Report 2019 P38-39 : Meiji Group's Approach to CSR > Progress on Materiality ➤ Integrated Report 2019 P40 : Healthier Lives > Policies & Plan ➤ Integrated Report 2019 P42 : Caring for the Earth > Policies & Plan/Environmental Management System ➤ Integrated Report 2019 P44 : A Richer Society > Policies & Plan ➤ Integrated Report 2019 P46 : Sustainable Procurement > Policies & Plan ➤ Integrated Report 2019 P59 : Risk Management ➤ Meiji Quality Comm
--------------	---	---	--

103: Management Approach			
103-3	Evaluation of the management approach	<p>a. An explanation of how the organization evaluates the management approach, including:</p> <ul style="list-style-type: none"> i. the mechanisms for evaluating the effectiveness of the management approach; ii. the results of the evaluation of the management approach; iii. any related adjustments to the management approach. 	<ul style="list-style-type: none"> ➤ Climate change > Environmental Management > Third-Party Certification ➤ Integrated Report 2019 P3 : Recognized for Outstanding Health Mangement in 2019

■ Topic Specific Standards

Economic

201: Economic Performance			
201-1	Direct economic value generated and distributed	<p>a. Direct economic value generated and distributed (EVG&D) on an accruals basis, including the basic components for the organization's global operations as listed below. If data are presented on a cash basis, report the justification for this decision in addition to reporting the following basic components:</p> <ul style="list-style-type: none"> i. Direct economic value generated: revenues; ii. Economic value distributed: operating costs, employee wages and benefits, payments to providers of capital, payments to government by country, and community investments; iii. Economic value retained: 'direct economic value generated' less 'economic value distributed'. <p>b. Where significant, report EVG&D separately at country, regional, or market levels, and the criteria used for defining significance.</p>	<ul style="list-style-type: none"> ➤ Integrated Report 2019 P74-102 : Notes to Consolidated Financial Statements ➤ Consolidated Financial Results p9-12 : Quarterly Consolidated Financial Statements (PDF:603KB)

201: Economic Performance

201-2

Financial implications and other risks and opportunities due to climate change

- a. Risks and opportunities posed by climate change that have the potential to generate substantive changes in operations, revenue, or expenditure, including:
- i. a description of the risk or opportunity and its classification as either physical, regulatory, or other;
 - ii. a description of the impact associated with the risk or opportunity;
 - iii. the financial implications of the risk or opportunity before action is taken;
 - iv. the methods used to manage the risk or opportunity;
 - v. the costs of actions taken to manage the risk or opportunity

- Business Risks
- ESG Data > Environment > Environmental investments
- Climate change > Environmental Management > Environmental Accounting

201: Economic Performance

201-3	Defined benefit plan obligations and other retirement plans	<p>a. If the plan's liabilities are met by the organization's general resources, the estimated value of those liabilities.</p> <p>b. If a separate fund exists to pay the plan's pension liabilities:</p> <ul style="list-style-type: none">i. the extent to which the scheme's liabilities are estimated to be covered by the assets that have been set aside to meet them;ii. the basis on which that estimate has been arrived at;iii. when that estimate was made. <p>c. If a fund set up to pay the plan's pension liabilities is not fully covered, explain the strategy, if any, adopted by the employer to work towards full coverage, and the timescale, if any, by which the employer hopes to achieve full coverage.</p> <p>d. Percentage of salary contributed by employee or employer.</p> <p>e. Level of participation in retirement plans, such as participation in mandatory or voluntary schemes, regional, or country-based schemes, or those with financial impact.</p>	<ul style="list-style-type: none">➤ Integrated Report 2019 P74-102 : Notes to Consolidated Financial Statements➤ Consolidated Financial Results p9-12 : Quarterly Consolidated Financial Statements (PDF:603KB)
-------	---	--	--

201: Economic Performance

201-4	Financial assistance received from government	<p>a. Total monetary value of financial assistance received by the organization from any government during the reporting period, including:</p> <ul style="list-style-type: none">i. tax relief and tax credits;ii. subsidies;iii. investment grants, research and development grants, and other relevant types of grant;iv. awards;v. royalty holidays;vi. financial assistance from Export Credit Agencies (ECAs);vii. financial incentives;viii. other financial benefits received or receivable from any government for any operation. <p>b. The information in 201-4-a by country.</p> <p>c. Whether, and the extent to which, any government is present in the shareholding structure.</p>	Not Disclosed
-------	---	---	---------------

202: Market Presence

--	--	--	--

201: Economic Performance

202-1	Ratios of standard entry level wage by gender compared to local minimum wage	<p>a. When a significant proportion of employees are compensated based on wages subject to minimum wage rules, report the relevant ratio of the entry level wage by gender at significant locations of operation to the minimum wage.</p> <p>b. When a significant proportion of other workers (excluding employees) performing the organization's activities are compensated based on wages subject to minimum wage rules, describe the actions taken to determine whether these workers are paid above the minimum wage.</p> <p>c. Whether a local minimum wage is absent or variable at significant locations of operation, by gender. In circumstances in which different minimums can be used as a reference, report which minimum wage is being used.</p> <p>d. The definition used for 'significant locations of operation'.</p>	Not Disclosed
202-2	Proportion of senior management hired from the local community	<p>a. Percentage of senior management at significant locations of operation that are hired from the local community.</p> <p>b. The definition used for 'senior management'.</p> <p>c. The organization's geographical definition of 'local'.</p> <p>d. The definition used for 'significant locations of operation'.</p>	Not Disclosed

203: Indirect Economic Impacts

--	--	--	--

201: Economic Performance			
203-1	Infrastructure investments and services supported	<p>a. Extent of development of significant infrastructure investments and services supported.</p> <p>b. Current or expected impacts on communities and local economies, including positive and negative impacts where relevant.</p> <p>c. Whether these investments and services are commercial, in-kind, or pro bono engagements.</p>	<p>➤ Society > Promote Social Contribution</p>
203-2	Significant indirect economic impacts	<p>a. Examples of significant identified indirect economic impacts of the organization, including positive and negative impacts.</p> <p>b. Significance of the indirect economic impacts in the context of external benchmarks and stakeholder priorities, such as national and international standards, protocols, and policy agendas.</p>	<p>➤ Health and Nutrition > Improve Nutrition in Emerging Countries > (3) Access to Medicine</p> <p>➤ Health and Nutrition > Ensure the Sustainable Supply of Pharmaceuticals > Access to Medicine</p>
204: Procurement Practices			
204-1	Proportion of spending on local suppliers	<p>a. Percentage of the procurement budget used for significant locations of operation that is spent on suppliers local to that operation (such as percentage of products and services purchased locally).</p> <p>b. The organization's geographical definition of 'local'.</p> <p>c. The definition used for 'significant locations of operation'.</p>	Not Disclosed
205: Anti-corruption			
205-1	Operations assessed for risks related to corruption	<p>a. Total number and percentage of operations assessed for risks related to corruption.</p> <p>b. Significant risks related to corruption identified through the risk assessment.</p>	Not Disclosed

201: Economic Performance

205-2

Communication and training about anti-corruption policies and procedures

- a. Total number and percentage of governance body members that the organization's anti-corruption policies and procedures have been communicated to, broken down by region.
- b. Total number and percentage of employees that the organization's anti-corruption policies and procedures have been communicated to, broken down by employee category and region.
- c. Total number and percentage of business partners that the organization's anti-corruption policies and procedures have been communicated to, broken down by type of business partner and region. Describe if the organization's anti-corruption policies and procedures have been communicated to any other persons or organizations.
- d. Total number and percentage of governance body members that have received training on anti-corruption, broken down by region.
- e. Total number and percentage of employees that have received training on anti-corruption, broken down by employee category and region.

➤ Mission and Vision >
Corporate Behavior Charter

201: Economic Performance			
205-3	Confirmed incidents of corruption and actions taken	<p>a. Total number and nature of confirmed incidents of corruption.</p> <p>b. Total number of confirmed incidents in which employees were dismissed or disciplined for corruption.</p> <p>c. Total number of confirmed incidents when contracts with business partners were terminated or not renewed due to violations related to corruption.</p> <p>d. Public legal cases regarding corruption brought against the organization or its employees during the reporting period and the outcomes of such cases.</p>	Not Disclosed
206: Anti-competitive Behavior			
206-1	Legal actions for anti-competitive behavior, anti-trust, and monopoly practices	<p>a. Number of legal actions pending or completed during the reporting period regarding anti-competitive behavior and violations of anti-trust and monopoly legislation in which the organization has been identified as a participant.</p> <p>b. Main outcomes of completed legal actions, including any decisions or judgments.</p>	Not Disclosed

Environmental

301: Materials			
301-1	Materials used by weight or volume	<p>a. Total weight or volume of materials that are used to produce and package the organization's primary products and services during the reporting period, by:</p> <p>i. non-renewable materials used;</p> <p>ii. renewable materials used.</p>	<p>➤ Climate change > Environmental Management > Material Balance</p> <p>➤ ESG Data > Environment > Circular Economy > Raw materials</p>

301: Materials			
301-2	Recycled input materials used	a. Percentage of recycled input materials used to manufacture the organization's primary products and services.	Not Disclosed
301-3	Reclaimed products and their packaging materials	a. Percentage of reclaimed products and their packaging materials for each product category. b. How the data for this disclosure have been collected.	Not Disclosed
302: Energy			
302-1	Energy consumption within the organization	<p>a. Total fuel consumption within the organization from non-renewable sources, in joules or multiples, and including fuel types used.</p> <p>b. Total fuel consumption within the organization from renewable sources, in joules or multiples, and including fuel types used.</p> <p>c. In joules, watt-hours or multiples, the total:</p> <ul style="list-style-type: none"> i. electricity consumption ii. heating consumption iii. cooling consumption iv. steam consumption <p>d. In joules, watt-hours or multiples, the total:</p> <ul style="list-style-type: none"> i. electricity sold ii. heating sold iii. cooling sold iv. steam sold <p>e. Total energy consumption within the organization, in joules or multiples.</p> <p>f. Standards, methodologies, assumptions, and / or calculation tools used.</p> <p>g. Source of the conversion factors used.</p>	<ul style="list-style-type: none"> ➤ Environmental Management > Material Balance ➤ ESG Data > Environment > Climate Change > Energy consumption ➤ Integrated Report 2019 P42 : Caring for the Earth > Climate Change > Introducing Renewable Energy > CO₂ Emission Volume for FY2018 ➤ Integrated Report 2019 P15/60-61 : Financial and Non-Financial Highlights > CO₂ emissions/Energy consumption volume
302-2	Energy consumption outside of the organization	<p>a. Energy consumption outside of the organization, in joules or multiples.</p> <p>b. Standards, methodologies, assumptions, and / or calculation tools used.</p> <p>c. Source of the conversion factors used.</p>	Not Disclosed

301: Materials

302-3	Energy intensity	<p>a. Energy intensity ratio for the organization.</p> <p>b. Organization-specific metric (the denominator) chosen to calculate the ratio.</p> <p>c. Types of energy included in the intensity ratio; whether fuel, electricity, heating, cooling, steam, or all.</p> <p>d. Whether the ratio uses energy consumption within the organization, outside of it, or both.</p>	<p>➤ ESG Data > Environment > Climate Change > Energy consumption > Per unit of sales</p> <p>➤ Integrated Report 2019 P15 : Financial and Non-Financial Highlights > Energy Consumption Volumes per Unit of Sales</p>
302-4	Reduction of energy consumption	<p>a. Amount of reductions in energy consumption achieved as a direct result of conservation and efficiency initiatives, in joules or multiples.</p> <p>b. Types of energy included in the reductions; whether fuel, electricity, heating, cooling, steam, or all.</p> <p>c. Basis for calculating reductions in energy consumption, such as base year or baseline, including the rationale for choosing it.</p> <p>d. Standards, methodologies, assumptions, and / or calculation tools used.</p>	<p>➤ ESG Data > Environment > Climate Change > Energy consumption</p> <p>➤ Integrated Report 2019 P15/60-61 : Financial and Non-Financial Highlights > Energy Consumption volume</p>
302-5	Reductions in energy requirements of products and services	<p>a. Reductions in energy requirements of sold products and services achieved during the reporting period, in joules or multiples.</p> <p>b. Basis for calculating reductions in energy consumption, such as base year or baseline, including the rationale for choosing it.</p> <p>c. Standards, methodologies, assumptions, and / or calculation tools used.</p>	Not Disclosed

303: Water

--	--	--	--

301: Materials

303-1	Water withdrawal by source	<p>a. Total volume of water withdrawn, with a breakdown by the following sources:</p> <ul style="list-style-type: none"> i. Surface water, including water from wetlands, rivers, lakes, and oceans; ii. Ground water; iii. Rainwater collected directly and stored by the organization; iv. Waste water from another organization; v. Municipal water supplies or other public or private water utilities. <p>b. Standards, methodologies, and assumptions used.</p>	<ul style="list-style-type: none"> ➤ Water > Secure Water Resources ➤ Integrated Report 2019 P43 : Water
303-2	Water sources significantly affected by withdrawal of water	<p>a. aTotal number of water sources significantly affected by withdrawal by type:</p> <ul style="list-style-type: none"> i. Size of the water source; ii. Whether the source is designated as a nationally or internationally protected area; iii. Biodiversity value (such as species diversity and endemism, and total number of protected species); iv. Value or importance of the water source to local communities and indigenous peoples. <p>b. Standards, methodologies, and assumptions used.</p>	<ul style="list-style-type: none"> ➤ Water > Secure Water Resources > Appropriate Water Management and Water Risks ➤ Integrated Report 2019 P43 : Water
303-3	Water recycled and reused	<p>a. Total volume of water recycled and reused by the organization.</p> <p>b. Total volume of water recycled and reused as a percentage of the total water withdrawal as specified in Disclosure 303-1.</p> <p>c. Standards, methodologies, and assumptions used.</p>	<ul style="list-style-type: none"> ➤ Climate change > Environmental Management > Material Balance > Water Resource Input Volume ➤ ESG Data > Environment > water > Total water used ➤ Integrated Report 2019 P43 : Water > Water Consumption Volume for FY2018 ➤ Integrated Report 2019 P15/60-61 : Financial and Non-Financial Highlights > Water consumption volume

301: Materials

303-4	Water withdrawal	<p>a. Total water withdrawal from all areas in megaliters, and a breakdown of this total by the following sources, if applicable:</p> <ul style="list-style-type: none">i. Surface water;ii. Groundwater;iii. Seawater;iv. Produced water;v. Third-party water. <p>b. Total water withdrawal from all areas with water stress in megaliters, and a breakdown of this total by the following sources, if applicable:</p> <ul style="list-style-type: none">i. Surface water;ii. Groundwater;iii. Seawater;iv. Produced water;v. Third-party water, and a breakdown of this total by the withdrawal sources listed in i-iv. <p>c. A breakdown of total water withdrawal from each of the sources listed in Disclosures 303-3-a and 303-3-b in megaliters by the following categories:</p> <ul style="list-style-type: none">i. Freshwater ($\leq 1,000$ mg/L Total Dissolved Solids);ii. Other water ($> 1,000$ mg/L Total Dissolved Solids). <p>d. Any contextual information necessary to understand how the data have been compiled, such as any standards, methodologies, and assumptions used.</p>	<ul style="list-style-type: none">▶ Environmental Management > Material Balance > Water Resource Input Volume :▶ ESG Data > Environment > water > Total water used▶ Integrated Report 2019 P43 : Water > Water Consumption Volume for FY2018▶ Integrated Report 2019 P15/60-61 : Financial and Non-Financial Highlights > Water consumption volume
-------	------------------	---	--

301: Materials

303-5	Water withdrawal	<p>a. Total water withdrawal from all areas in megaliters, and a breakdown of this total by the following sources, if applicable:</p> <ul style="list-style-type: none"> i. Surface water; ii. Groundwater; iii. Seawater; iv. Produced water; v. Third-party water. <p>b. Total water withdrawal from all areas with water stress in megaliters, and a breakdown of this total by the following sources, if applicable:</p> <ul style="list-style-type: none"> i. Surface water; ii. Groundwater; iii. Seawater; iv. Produced water; v. Third-party water, and a breakdown of this total by the withdrawal sources listed in i-iv. <p>c. A breakdown of total water withdrawal from each of the sources listed in Disclosures 303-3-a and 303-3-b in megaliters by the following categories:</p> <ul style="list-style-type: none"> i. Freshwater ($\leq 1,000$ mg/L Total Dissolved Solids); ii. Other water ($> 1,000$ mg/L Total Dissolved Solids). <p>d. Any contextual information necessary to understand how the data have been compiled, such as any standards, methodologies, and assumptions used.</p>	<ul style="list-style-type: none"> ➤ Environmental Management > Material Balance > Water Resource Input Volume : ➤ ESG Data > Environment > water > Total water used ➤ Integrated Report 2019 P43 : Water > Water Consumption Volume for FY2018 ➤ Integrated Report 2019 P15/60-61 : Financial and Non-Financial Highlights > Water consumption volume
-------	------------------	--	---

304: Biodiversity

--	--	--	--

301: Materials



304-1

Operational sites owned, leased, managed in, or adjacent to, protected areas and areas of high biodiversity value outside protected areas

- a. For each operational site owned, leased, managed in, or adjacent to, protected areas and areas of high biodiversity value outside protected areas, the following information:
- i. Geographic location;
 - ii. Subsurface and underground land that may be owned, leased, or managed by the organization;
 - iii. Position in relation to the protected area (in the area, adjacent to, or containing portions of the protected area) or the high biodiversity value area outside protected areas;
 - iv. Type of operation (office, manufacturing or production, or extractive);
 - v. Size of operational site in km² (or another unit, if appropriate);
 - vi. Biodiversity value characterized by the attribute of the protected area or area of high biodiversity value outside the protected area (terrestrial, freshwater, or maritime ecosystem);
 - vii. Biodiversity value characterized by listing of protected status (such as IUCN Protected Area Management Categories, Ramsar Convention, national legislation).

- [▶ ESG Data > Environment > Biodiversity](#)
- [▶ Biodiversity](#)

301: Materials

<p>304-2</p>	<p>Significant impacts of activities, products, and services on biodiversity</p>	<p>a. Nature of significant direct and indirect impacts on biodiversity with reference to one or more of the following:</p> <ul style="list-style-type: none"> i. Construction or use of manufacturing plants, mines, and transport infrastructure; ii. Pollution (introduction of substances that do not naturally occur in the habitat from point and non-point sources); iii. Introduction of invasive species, pests, and pathogens; iv. Reduction of species; v. Habitat conversion; vi. Changes in ecological processes outside the natural range of variation (such as salinity or changes in groundwater level). <p>b. Significant direct and indirect positive and negative impacts with reference to the following:</p> <ul style="list-style-type: none"> i. Species affected; ii. Extent of areas impacted; iii. Duration of impacts; iv. Reversibility or irreversibility of the impacts. 	<p> Biodiversity</p>
<p>304-3</p>	<p>Habitats protected or restored</p>	<p>a. Size and location of all habitat areas protected or restored, and whether the success of the restoration measure was or is approved by independent external professionals.</p> <p>b. Whether partnerships exist with third parties to protect or restore habitat areas distinct from where the organization has overseen and implemented restoration or protection measures.</p> <p>c. Status of each area based on its condition at the close of the reporting period.</p> <p>d. Standards, methodologies, and assumptions used.</p>	<p> Biodiversity > Secure Local Biodiversity > Biodiversity Conservation in the Nemuro Nature Conservation Area</p>

301: Materials

304-4	IUCN Red List species and national conservation list species with habitats in areas affected by operations	<p>a. Total number of IUCN Red List species and national conservation list species with habitats in areas affected by the operations of the organization, by level of extinction risk:</p> <ul style="list-style-type: none"> i. Critically endangered ii. Endangered iii. Vulnerable iv. Near threatened v. Least concern 	<ul style="list-style-type: none"> ➤ Biodiversity > Secure Local Biodiversity > Biodiversity Conservation in the Nemuro Nature Conservation Area
-------	--	---	---

305: Emissions

305-1	Direct (Scope 1) GHG emissions	<p>a. Gross direct (Scope 1) GHG emissions in metric tons of CO₂ equivalent.</p> <p>b. Gases included in the calculation; whether CO₂, CH₄, N₂O, HFCs, PFCs, SF₆, NF₃, or all.</p> <p>c. Biogenic CO₂ emissions in metric tons of CO₂ equivalent.</p> <p>d. Base year for the calculation, if applicable, including:</p> <ul style="list-style-type: none"> i. the rationale for choosing it; ii. emissions in the base year; iii. the context for any significant changes in emissions that triggered recalculations of base year emissions. <p>e. Source of the emission factors and the global warming potential (GWP) rates used, or a reference to the GWP source.</p> <p>f. Consolidation approach for emissions; whether equity share, financial control, or operational control.</p> <p>g. Standards, methodologies, assumptions, and / or calculation tools used.</p>	<ul style="list-style-type: none"> ➤ Environmental Management > Material Balance ➤ ESG Data > Environment > Climate Change > Energy consumption / CO₂ emissions ➤ Integrated Report 2019 P42 : Caring for the Earth > Climate Change > Introducing Renewable Energy > CO₂ Emission Volume for FY2018 ➤ Integrated Report 2019 P60-61 : Financial and Non-Financial Highlights > CO₂ emissions
-------	--------------------------------	---	--

301: Materials

305-2	Energy indirect (Scope 2) GHG emissions	<p>a. Gross location-based energy indirect (Scope 2) GHG emissions in metric tons of CO₂ equivalent.</p> <p>b. If applicable, gross market-based energy indirect (Scope 2) GHG emissions in metric tons of CO₂ equivalent.</p> <p>c. If available, the gases included in the calculation; whether CO₂, CH₄, N₂O, HFCs, PFCs, SF₆, NF₃, or all.</p> <p>d. Base year for the calculation, if applicable, including:</p> <ul style="list-style-type: none">i. the rationale for choosing it;ii. emissions in the base year;iii. the context for any significant changes in emissions that triggered recalculations of base year emissions. <p>e. Source of the emission factors and the global warming potential (GWP) rates used, or a reference to the GWP source.</p> <p>f. Consolidation approach for emissions; whether equity share, financial control, or operational control.</p> <p>g. Standards, methodologies, assumptions, and / or calculation tools used.</p>	<ul style="list-style-type: none">▶ ESG Data > Environment > Climate Change > Energy consumption / CO₂ emissions▶ Integrated Report 2019 P42 : Caring for the Earth > Climate Change > Introducing Renewable Energy > CO₂ Emission Volume for FY2018▶ Integrated Report 2019 P15/60-61 : Financial and Non-Financial Highlights > CO₂ emissions
-------	---	---	---

301: Materials

<p>305-3</p>	<p>Other indirect (Scope 3) GHG emissions</p>	<p>a. Gross other indirect (Scope 3) GHG emissions in metric tons of CO₂ equivalent.</p> <p>b. If available, the gases included in the calculation; whether CO₂, CH₄, N₂O, HFCs, PFCs, SF₆, NF₃, or all.</p> <p>c. Biogenic CO₂ emissions in metric tons of CO₂ equivalent.</p> <p>d. Other indirect (Scope 3) GHG emissions categories and activities included in the calculation.</p> <p>e. Base year for the calculation, if applicable, including:</p> <ul style="list-style-type: none"> i. the rationale for choosing it; ii. emissions in the base year; iii. the context for any significant changes in emissions that triggered recalculations of base year emissions. <p>f. Source of the emission factors and the global warming potential (GWP) rates used, or a reference to the GWP source.</p> <p>g. Standards, methodologies, assumptions, and / or calculation tools used.</p>	<ul style="list-style-type: none"> ➤ ESG Data > Environment > Climate Change > CO₂ emissions ➤ Integrated Report 2019 P42 : Caring for the Earth > Climate Change > Introducing Renewable Energy > CO₂ Emission Volume for FY2018 ➤ Integrated Report 2019 P60-61 : Financial and Non-Financial Highlights > CO₂ emissions
<p>305-4</p>	<p>GHG emissions intensity</p>	<p>a. GHG emissions intensity ratio for the organization.</p> <p>b. Organization-specific metric (the denominator) chosen to calculate the ratio.</p> <p>c. Types of GHG emissions included in the intensity ratio; whether direct (Scope 1), energy indirect (Scope 2), and / or other indirect (Scope 3).</p> <p>d. Gases included in the calculation; whether CO₂, CH₄, N₂O, HFCs, PFCs, SF₆, NF₃, or all.</p>	<ul style="list-style-type: none"> ➤ ESG Data > Environment > Climate Change > CO₂ emissions volume per production unit ➤ Integrated Report 2019 P42 : Caring for the Earth > Climate Change > Introducing Renewable Energy > CO₂ Emission Volume for FY2018

301: Materials

305-5	Reduction of GHG emissions	<p>a. GHG emissions reduced as a direct result of reduction initiatives, in metric tons of CO₂ equivalent.</p> <p>b. Gases included in the calculation; whether CO₂, CH₄, N₂O, HFCs, PFCs, SF₆, NF₃, or all.</p> <p>c. Base year or baseline, including the rationale for choosing it.</p> <p>d. Scopes in which reductions took place; whether direct (Scope 1), energy indirect (Scope 2), and / or other indirect (Scope 3).</p> <p>e. Standards, methodologies, assumptions, and / or calculation tools used.</p>	<p>➤ ESG Data > Environment > Climate Change > CO₂ emissions</p> <p>➤ Integrated Report 2019 P42 : Caring for the Earth > Climate Change > Introducing Renewable Energy > CO₂ Emission Volume for FY2018</p> <p>➤ Integrated Report 2019 P60-61 : Financial and Non-Financial Highlights > CO₂ emissions</p>
305-6	Emissions of ozone-depleting substances (ODS)	<p>a. Production, imports, and exports of ODS in metric tons of CFC-11 (trichlorofluoromethane) equivalent.</p> <p>b. Substances included in the calculation.</p> <p>c. Source of the emission factors used.</p> <p>d. Standards, methodologies, assumptions, and / or calculation tools used.</p>	<p>➤ ESG Data > Environment > Appropriate management of chemical substances</p>
305-7	Nitrogen oxides (NO _x), sulfur oxides (SO _x), and other significant air emissions	<p>a. Significant air emissions, in kilograms or multiples, for each of the following:</p> <ul style="list-style-type: none"> i. NO_x ii. SO_x iii. Persistent organic pollutants (POP) iv. Volatile organic compounds (VOC) v. Hazardous air pollutants (HAP) vi. Particulate matter (PM) vii. Other standard categories of air emissions identified in relevant regulations <p>b. Source of the emission factors used.</p> <p>c. Standards, methodologies, assumptions, and / or calculation tools used.</p>	<p>➤ Environmental Management > Material Balance</p> <p>➤ ESG Data > Environment > Appropriate management of chemical substances</p>

306: Effluents and Waste

301: Materials

306-1	Water discharge by quality and destination	<p>a. Total volume of planned and unplanned water discharges by:</p> <ol style="list-style-type: none"> i. destination; ii. quality of the water, including treatment method; iii. whether the water was reused by another organization. <p>b. Standards, methodologies, and assumptions used.</p>	<ul style="list-style-type: none"> ➤ Environmental Management > Material Balance ➤ ESG Data > Environment > Water ➤ Integrated Report 2019 P43 : Water ➤ Integrated Report 2019 P60-61 : Financial and Non-Financial Highlights > Total water discharge volume
306-2	Waste by type and disposal method	<p>a. Total weight of hazardous waste, with a breakdown by the following disposal methods where applicable:</p> <ol style="list-style-type: none"> i. Reuse ii. Recycling iii. Composting iv. Recovery, including energy recovery v. Incineration (mass burn) vi. Deep well injection vii. Landfill viii. On-site storage ix. Other (to be specified by the organization) <p>b. Total weight of non-hazardous waste, with a breakdown by the following disposal methods where applicable:</p> <ol style="list-style-type: none"> i. Reuse ii. Recycling iii. Composting iv. Recovery, including energy recovery v. Incineration (mass burn) vi. Deep well injection vii. Landfill viii. On-site storage ix. Other (to be specified by the organization) <p>c. How the waste disposal method has been determined:</p> <ol style="list-style-type: none"> i. Disposed of directly by the organization, or otherwise directly confirmed ii. Information provided by the waste disposal contractor iii. Organizational defaults of the waste disposal contractor 	<ul style="list-style-type: none"> ➤ ESG Data > Environment > Circular Economy > Total waste

301: Materials

306-3	Significant spills	<p>a. Total number and total volume of recorded significant spills.</p> <p>b. The following additional information for each spill that was reported in the organization's financial statements:</p> <ul style="list-style-type: none">i. Location of spill;ii. Volume of spill;iii. Material of spill, categorized by: oil spills (soil or water surfaces), fuel spills (soil or water surfaces), spills of wastes (soil or water surfaces), spills of chemicals (mostly soil or water surfaces), and other (to be specified by the organization). <p>c. Impacts of significant spills.</p>	Not Disclosed
306-4	Transport of hazardous waste	<p>a. Total weight for each of the following:</p> <ul style="list-style-type: none">i. Hazardous waste transportedii. Hazardous waste importediii. Hazardous waste exportediv. Hazardous waste treated <p>b. Percentage of hazardous waste shipped internationally.</p> <p>c. Standards, methodologies, and assumptions used.</p>	Not Disclosed
306-5	Water bodies affected by water discharges and / or runoff	<p>a. Water bodies and related habitats that are significantly affected by water discharges and / or runoff, including information on:</p> <ul style="list-style-type: none">i. the size of the water body and related habitat;ii. whether the water body and related habitat is designated as a nationally or internationally protected area;iii. the biodiversity value, such as total number of protected species.	Not Disclosed

307: Environmental Compliance

301: Materials			
307-1	Non-compliance with environmental laws and regulations	<p>a. Significant fines and non-monetary sanctions for non-compliance with environmental laws and / or regulations in terms of:</p> <ul style="list-style-type: none"> i. total monetary value of significant fines; ii. total number of non-monetary sanctions; iii. cases brought through dispute resolution mechanisms. <p>b. If the organization has not identified any non-compliance with environmental laws and / or regulations, a brief statement of this fact is sufficient.</p>	<p>➤ ESG Data > Environment > Number of violation of environmental laws and regulations</p>
308: Supplier Environmental Assessment			
308-1	New suppliers that were screened using environmental criteria	a. Percentage of new suppliers that were screened using environmental criteria.	Not Disclosed
308-2	Negative environmental impacts in the supply chain and actions taken	<p>a. Number of suppliers assessed for environmental impacts.</p> <p>b. Number of suppliers identified as having significant actual and potential negative environmental impacts.</p> <p>c. Significant actual and potential negative environmental impacts identified in the supply chain.</p> <p>d. Percentage of suppliers identified as having significant actual and potential negative environmental impacts with which improvements were agreed upon as a result of assessment.</p> <p>e. Percentage of suppliers identified as having significant actual and potential negative environmental impacts with which relationships were terminated as a result of assessment, and why.</p>	<p>➤ Sustainable Procurement > Procure Raw Materials With Consideration Toward Human Rights and the Environment > Supplier Assessment > Supplier Assessment in Accordance With the Meiji Group Procurement Policy</p>

Social

--

401: Employment			
401-1	New employee hires and employee turnover	<p>a. Total number and rate of new employee hires during the reporting period, by age group, gender and region.</p> <p>b. Total number and rate of employee turnover during the reporting period, by age group, gender and region.</p>	<p>🔴 ESG Data > Society > Turnover rate (less than 3 years for new graduates) / New employees</p>
401-2	Benefits provided to full-time employees that are not provided to temporary or part-time employees	<p>a. Benefits which are standard for full-time employees of the organization but are not provided to temporary or part-time employees, by significant locations of operation. These include, as a minimum:</p> <ul style="list-style-type: none"> i. life insurance; ii. health care; iii. disability and invalidity coverage; iv. parental leave; v. retirement provision; vi. stock ownership; vii. others. <p>b. The definition used for 'significant locations of operation'.</p>	Not Disclosed
401-3	Parental leave	<p>a. Total number of employees that were entitled to parental leave, by gender.</p> <p>b. Total number of employees that took parental leave, by gender.</p> <p>c. Total number of employees that returned to work in the reporting period after parental leave ended, by gender.</p> <p>d. Total number of employees that returned to work after parental leave ended that were still employed 12 months after their return to work, by gender.</p> <p>e. Return to work and retention rates of employees that took parental leave, by gender.</p>	<p>🔴 ESG Data > Society > Child care leave / Shortened working hours for child purposes / Return to work rates after child care leave / Retention rates after two months of child care leave</p> <p>🔴 Human Resources > Promote Diversity and Inclusion, and Provide Training to Employees > Work-life Balance</p>
402: Labor / Management Relations			

401: Employment

402-1	Minimum notice periods regarding operational changes	<p>a. Minimum number of weeks' notice typically provided to employees and their representatives prior to the implementation of significant operational changes that could substantially affected them.</p> <p>b. For organizations with collective bargaining agreements, report whether the notice period and provisions for consultation and negotiation are specified in collective agreements.</p>	Not Disclosed
-------	--	--	---------------

403: Occupational Health and Safety

403-1	Workers representation in formal joint management-worker health and safety committees	<p>a. The level at which each formal joint management-worker health and safety committee typically operates within the organization.</p> <p>b. Percentage of workers whose work, or workplace, is controlled by the organization, that are represented by formal joint management-worker health and safety committees.</p>	▶ Human Resources > Employee-friendly Workplaces > Occupational Health and Safety > Labor Relations
403-2	Types of injury and rates of injury, occupational diseases, lost days, and absenteeism, and number of work-related fatalities	<p>a. Types of injury, injury rate (IR), occupational disease rate (ODR), lost day rate (LDR), absentee rate (AR), and work-related fatalities, for all employees, with a breakdown by:</p> <ul style="list-style-type: none">i. region;ii. gender. <p>b. Types of injury, injury rate (IR), and work-related fatalities, for all workers (excluding employees) whose work, or workplace, is controlled by the organization, with a breakdown by:</p> <ul style="list-style-type: none">i. region;ii. gender. <p>c. The system of rules applied in recording and reporting accident statistics.</p>	▶ Human Resources > Employee-friendly Workplaces > Occupational Health and Safety > Reducing Equipment- and Work-Related Risks and Performing Safety Audits and Inspections

401: Employment			
403-3	Workers with high incidence or high risk of diseases related to their occupation	a. Whether there are workers whose work, or workplace, is controlled by the organization, involved in occupational activities who have a high incidence or high risk of specific diseases.	Not Disclosed
403-4	Health and safety topics covered in formal agreements with trade unions	a. Whether formal agreements (either local or global) with trade unions cover health and safety. b. If so, the extent, as a percentage, to which various health and safety topics are covered by these agreements.	Human Resources > Employee-friendly Workplaces > Occupational Health and Safety > Labor Relations
403-5	Worker training on occupational health and safety	a. A description of any occupational health and safety training provided to workers, including generic training as well as training on specific work-related hazards, hazardous activities, or hazardous situations.	Human Resources > Employee-friendly Workplaces > Occupational Health and Safety > Occupational Safety and Health Training at Each Business and Operating Base
403-6	Promotion of worker health	a. An explanation of how the organization facilitates workers' access to non-occupational medical and healthcare services, and the scope of access provided. b. A description of any voluntary health promotion services and programs offered to workers to address major non-work-related health risks, including the specific health risks addressed, and how the organization facilitates workers' access to these services and programs.	Human Resources > Employee-friendly Workplaces > Occupational Health and Safety > Encourage Personal Health Management
403-7	Prevention and mitigation of occupational health and safety impacts directly linked by business relationships	a. . A description of the organization's approach to preventing or mitigating significant negative occupational health and safety impacts that are directly linked to its operations, products or services by its business relationships, and the related hazards and risks.	Not Disclosed

401: Employment

403-8	Workers covered by an occupational health and safety management system	<p>a. a. If the organization has implemented an occupational health and safety management system based on legal requirements and/or recognized standards/guidelines:</p> <ul style="list-style-type: none"> i. the number and percentage of all employees and workers who are not employees but whose work and/or workplace is controlled by the organization, who are covered by such a system; ii. the number and percentage of all employees and workers who are not employees but whose work and/or workplace is controlled by the organization, who are covered by such a system that has been internally audited; iii. the number and percentage of all employees and workers who are not employees but whose work and/or workplace is controlled by the organization, who are covered by such a system that has been audited or certified by an external party. <p>b. Whether and, if so, why any workers have been excluded from this disclosure, including the types of worker excluded.</p> <p>c. Any contextual information necessary to understand how the data have been compiled, such as any standards, methodologies, and assumptions used.</p>	<ul style="list-style-type: none"> ➤ Human Resources > Employee-friendly Workplaces > Occupational Health and Safety
403-9	Work-related injuries	<p>a. For all employees:</p> <ul style="list-style-type: none"> i. The number and rate of fatalities as a result of work-related injury; ii. The number and rate of high-consequence work-related injuries (excluding fatalities); iii. The number and rate of recordable work-related 	<ul style="list-style-type: none"> ➤ Human Resources > Employee-friendly Workplaces > Occupational Health and Safety > Reducing Equipment- and Work-Related Risks and Performing Safety Audits and Inspections ➤ ESG Data > Society > Frequency rate of lost-worktime injuries (permanent

401: Employment			
		<p>injuries;</p> <p>iv. The main types of work-related injury;</p> <p>v. The number of hours worked.</p> <p>b. For all workers who are not employees but whose work and/or workplace is controlled by the organization:</p> <p>i. The number and rate of fatalities as a result of work-related injury;</p> <p>ii. The number and rate of high-consequence work-related injuries (excluding fatalities);</p> <p>iii. The number and rate of recordable work-related injuries;</p> <p>iv. The main types of work-related injury;</p> <p>v. The number of hours worked.</p> <p>c. The work-related hazards that pose a risk of high-consequence injury, including:</p> <p>i. how these hazards have been determined;</p> <p>ii. which of these hazards have caused or contributed to high-consequence injuries during the reporting period;</p> <p>iii. actions taken or underway to eliminate these hazards and minimize risks using the hierarchy of controls.</p> <p>d. Any actions taken or underway to eliminate other work-related hazards and minimize risks using the hierarchy of controls.</p> <p>e. Whether the rates have been calculated based on 200,000 or 1,000,000 hours worked.</p> <p>f. Whether and, if so, why any workers have been excluded from this disclosure, including the types of worker excluded.</p> <p>g. Any contextual information necessary to understand how the data have been compiled, such as any</p>	<p>employment basis, Japan)/Lost-Time Injury Severity Rate/Number of Work-Related Fatalities</p> <p>➤ ESG Data > Society > Frequency rate of lost-worktime injuries (permanent employment basis, Japan)/Lost-Time Injury Severity Rate/Number of Work-Related Fatalities</p> <p>➤ Integrated Report 2019 P15 : Financial and Non-Financial Highlights > Lost Time Injury Frequency Rate (LTIFR)</p>

401: Employment			
		standards, methodologies, and assumptions used.	
403-10	Work-related ill health	<p>a. For all employees:</p> <ul style="list-style-type: none"> i. The number of fatalities as a result of work-related ill health; ii. The number of cases of recordable work-related ill health; iii. The main types of work-related ill health. <p>b. For all workers who are not employees but whose work and/or workplace is controlled by the organization:</p> <ul style="list-style-type: none"> i. The number of fatalities as a result of work-related ill health; ii. The number of cases of recordable work-related ill health; iii. The main types of work-related ill health. <p>c. The work-related hazards that pose a risk of ill health, including:</p> <ul style="list-style-type: none"> i. how these hazards have been determined; ii. which of these hazards have caused or contributed to cases of ill health during the reporting period; iii. actions taken or underway to eliminate these hazards and minimize risks using the hierarchy of controls. <p>d. Whether and, if so, why any workers have been excluded from this disclosure, including the types of worker excluded.</p> <p>e. Any contextual information necessary to understand how the data have been compiled, such as any standards, methodologies, and assumptions used.</p>	Not Disclosed
404: Training			

401: Employment

404-1	Average hours of training per year per employee	a. Average hours of training that the organization's employees have undertaken during the reporting period, by: i. gender; ii. employee category.	Not Disclosed
404-2	Programs for upgrading employee skills and transition assistance programs	a. Type and scope of programs implemented and assistance provided to upgrade employee skills. b. Transition assistance programs provided to facilitate continued employability and the management of career endings resulting from retirement or termination of employment.	<ul style="list-style-type: none">➤ Human Resources > Promote Diversity and Inclusion, and Provide Training to Employees > Evaluation and Development of Personnel / Personnel Development➤ Integrated Report 2019 P44 : A Richer Society > Personnel Training
404-3	Percentage of employees receiving regular performance and career development reviews	a. Percentage of total employees by gender and by employee category who received a regular performance and career development review during the reporting period.	<ul style="list-style-type: none">➤ Human Resources > Promote Diversity and Inclusion, and Provide Training to Employees > Evaluation and Development of Personnel / Personnel Development➤ Integrated Report 2019 P44 : A Richer Society > Personnel Training

405: Diversity and Equal Opportunity

--	--	--	--

401: Employment

405-1	Diversity of governance bodies and employees	<p>a. Percentage of individuals within the organization's governance bodies in each of the following diversity categories:</p> <ol style="list-style-type: none"> i. Gender; ii. Age group: under 30 years old, 30-50 years old, over 50 years old; iii. Other indicators of diversity where relevant (such as minority or vulnerable groups). <p>b. Percentage of employees per employee category in each of the following diversity categories:</p> <ol style="list-style-type: none"> i. Gender; ii. Age group: under 30 years old, 30-50 years old, over 50 years old; iii. Other indicators of diversity where relevant (such as minority or vulnerable groups). 	<ul style="list-style-type: none"> ➤ Human Resources > Promote Diversity and Inclusion, and Provide Training to Employees > Diverse Employees / Empowerment of Female Employees / Employment of Persons with Disabilities ➤ ESG Data > Society > Female manager ratio as percentage of total / Female executive officers ratio as percentage of total / Number seeking reemployment / Percentage of applicants reemployed ➤ ESG Data > Governance > Number of Board of Directors/Number of Audit & Supervisory Board Members/Number of Nomination Committee Members/Number of Compensation Committee Members : ➤ Corporate Governance > Corporate Governance System ➤ Integrated Report 2019 P39 : A Richer Society > Human Resources
405-2	Ratio of basic salary and remuneration of women to men	<p>a. Ratio of the basic salary and remuneration of women to men for each employee category, by significant locations of operation.</p> <p>b. The definition used for 'significant locations of operation'.</p>	Not Disclosed

406: Non-discrimination

406-1	Incidents of discrimination and corrective actions taken	<p>a. Total number of incidents of discrimination during the reporting period.</p> <p>b. Status of the incidents and actions taken with reference to the following:</p> <ol style="list-style-type: none"> i. Incident reviewed by the organization; ii. Remediation plans being implemented; iii. Remediation plans that have been implemented, with results reviewed through routine internal management review processes; iv. Incident no longer subject to action. 	<ul style="list-style-type: none"> ➤ Society > Respect and Promote Human Rights > Initiatives Related to Human Rights Due Diligence
-------	--	--	--

401: Employment

407: Freedom of Association and Collective Bargaining

407-1	Operations and suppliers in which the right to freedom of association and collective bargaining may be at risk	<p>a. Operations and suppliers in which workers' rights to exercise freedom of association or collective bargaining may be violated or at significant risk either in terms of:</p> <ul style="list-style-type: none">i. type of operation (such as manufacturing plant) and supplier;ii. countries or geographic areas with operations and suppliers considered at risk. <p>b. Measures taken by the organization in the reporting period intended to support rights to exercise freedom of association and collective bargaining.</p>	Not Disclosed
-------	--	---	---------------

408: Child Labor

408-1	Operations and suppliers at significant risk for incidents of child labor	<p>a. Operations and suppliers considered to have significant risk for incidents of:</p> <ul style="list-style-type: none">i. child labor;ii. young workers exposed to hazardous work. <p>b. Operations and suppliers considered to have significant risk for incidents of child labor either in terms of:</p> <ul style="list-style-type: none">i. type of operation (such as manufacturing plant) and supplier;ii. countries or geographic areas with operations and suppliers considered at risk. <p>c. Measures taken by the organization in the reporting period intended to contribute to the effective abolition of child labor.</p>	<ul style="list-style-type: none">➤ Society > Respect and Promote Human Rights > Initiatives Related to Human Rights Due Diligence➤ Integrated Report 2019 P45 : A Richer Society > Society > Respect and Promote Human Rights > Implementing Human Rights Due Diligence➤ Integrated Report 2019 P46 : Sustainable Procurement > Procurement > Formulating and Disclosure of Procurement Guidelines
-------	---	---	--

409: Forced or Compulsory Labor

401: Employment			
409-1	Operations and suppliers at significant risk for incidents of forced or compulsory labor	<p>a. Operations and suppliers considered to have significant risk for incidents of forced or compulsory labor either in terms of:</p> <ul style="list-style-type: none"> i. type of operation (such as manufacturing plant) and supplier; ii. countries or geographic areas with operations and suppliers considered at risk. <p>b. Measures taken by the organization in the reporting period intended to contribute to the elimination of all forms of forced or compulsory labor.</p>	<ul style="list-style-type: none"> ➤ Society > Respect and Promote Human Rights > Initiatives Related to Human Rights Due Diligence ➤ Integrated Report 2019 P45 : A Richer Society > Society > Respect and Promote Human Rights > Implementing Human Rights Due Diligence ➤ Integrated Report 2019 P46 : Sustainable Procurement > Procurement > Formulating and Disclosure of Procurement Guidelines
410: Security Practices			
410-1	Security personnel trained in human rights policies or procedures	<p>a. Percentage of security personnel who have received formal training in the organization's human rights policies or specific procedures and their application to security.</p> <p>b. Whether training requirements also apply to third-party organizations providing security personnel.</p>	Not Disclosed
411: Management approach disclosures			
411-1	Incidents of violations involving rights of indigenous peoples	<p>a. Total number of identified incidents of violations involving the rights of indigenous peoples during the reporting period.</p> <p>b. Status of the incidents and actions taken with reference to the following:</p> <ul style="list-style-type: none"> i. Incident reviewed by the organization; ii. Remediation plans being implemented; iii. Remediation plans that have been implemented, with results reviewed through routine internal management review processes; iv. Incident no longer subject to action. 	<ul style="list-style-type: none"> ➤ Policies > Meiji Group Policy on Human Rights ➤ Integrated Report 2019 P45 : A Richer Society > Society > Respect and Promote Human Rights > Implementing Human Rights Due Diligence ➤ Integrated Report 2019 P46 : Sustainable Procurement > Procurement > Formulating and Disclosure of Procurement Guidelines
412: Human Rights Assessment			

401: Employment

412-1	Operations that have been subject to human rights reviews or impact assessments	a. Total number and percentage of operations that have been subject to human rights reviews or human rights impact assessments, by country.	<ul style="list-style-type: none"> ➤ Society > Respect and Promote Human Rights > Initiatives Related to Human Rights Due Diligence ➤ Integrated Report 2019 P45 : A Richer Society > Society > Respect and Promote Human Rights > Implementing Human Rights Due Diligence ➤ Integrated Report 2019 P46 : Sustainable Procurement > Procurement > Formulating and Disclosure of Procurement Guidelines
412-2	Employee training on human rights policies or procedures	<p>a. Total number of hours in the reporting period devoted to training on human rights policies or procedures concerning aspects of human rights that are relevant to operations.</p> <p>b. Percentage of employees trained during the reporting period in human rights policies or procedures concerning aspects of human rights that are relevant to operations.</p>	<ul style="list-style-type: none"> ➤ Society > Respect and Promote Human Rights > Human Rights Education and Training ➤ ESG Data > Society > Human Resources > Number of employees trained in human rights policy ➤ Integrated Report 2019 P39 : A Richer Society > Society > Respect and promote human rights > Employees receive training on human rights
412-3	Significant investment agreements and contracts that include human rights clauses or that underwent human rights screening	<p>a. Total number and percentage of significant investment agreements and contracts that include human rights clauses or that underwent human rights screening.</p> <p>b. The definition used for 'significant investment agreements'.</p>	Not Disclosed

413: Local Communities

--	--	--	--

401: Employment

413-1	Operations with local community engagement, impact assessments, and development programs	<p>a. Percentage of operations with implemented local community engagement, impact assessments, and / or development programs, including the use of:</p> <ul style="list-style-type: none"> i. social impact assessments, including gender impact assessments, based on participatory processes; ii. environmental impact assessments and ongoing monitoring; iii. public disclosure of results of environmental and social impact assessments; iv. local community development programs based on local communities' needs; v. stakeholder engagement plans based on stakeholder mapping; vi. broad based local community consultation committees and processes that include vulnerable groups; vii. works councils, occupational health and safety committees and other worker representation bodies to deal with impacts; viii. formal local community grievance processes. 	<ul style="list-style-type: none"> ➤ Society > Communicate with Stakeholders ➤ Society > Promote Social Contribution ➤ Sustainable Procurement > Initiatives for Sustainable Procurement > Expanding Meiji Cocoa Support ➤ Integrated Report 2019 P30-33 : Working Toward Sustainable Cocoa Production > What is Meiji Cocoa Support?/Meiji Cocoa Support
413-2	Operations with significant actual and potential negative impacts on local communities	<p>a. Operations with significant actual and potential negative impacts on local communities, including:</p> <ul style="list-style-type: none"> i. the location of the operations; ii. the significant actual and potential negative impacts of operations. 	Not Disclosed

414: Supplier Social Assessment

414-1	New suppliers that were screened using social criteria	<p>a. Percentage of new suppliers that were screened using social criteria.</p>	Not Disclosed
-------	--	---	---------------

401: Employment			
414-2	Negative social impacts in the supply chain and actions taken	<p>a. Number of suppliers assessed for social impacts.</p> <p>b. Number of suppliers identified as having significant actual and potential negative social impacts.</p> <p>c. Significant actual and potential negative social impacts identified in the supply chain.</p> <p>d. Percentage of suppliers identified as having significant actual and potential negative social impacts with which improvements were agreed upon as a result of assessment.</p> <p>e. Percentage of suppliers identified as having significant actual and potential negative social impacts with which relationships were terminated as a result of assessment, and why.</p>	<p>➤ Sustainable Procurement > Procure Raw Materials With Consideration Toward Human Rights and the Environment > Supplier Assessment > Supplier Assessment in Accordance With the Meiji Group Procurement Policy</p>
415: Public Policy			
415-1	Political contributions	<p>a. Total monetary value of financial and in-kind political contributions made directly and indirectly by the organization by country and recipient / beneficiary.</p> <p>b. If applicable, how the monetary value of in-kind contributions was estimated.</p>	Not Disclosed
416: Customer Health and Safety			
416-1	Assessment of the health and safety impacts of product and service categories	<p>a. Percentage of significant product and service categories for which health and safety impacts are assessed for improvement.</p>	<p>➤ Quality and Safety > Ensure Product Quality and Safety</p> <p>➤ Quality Management system - "Meiji Quality Comm"</p> <p>➤ Integrated Report 2019 P38 : Healthier Lives > Quality and Safety</p>

401: Employment

416-2	Incidents of non-compliance concerning the health and safety impacts of products and services	<p>a. Total number of incidents of non-compliance with regulations and / or voluntary codes concerning the health and safety impacts of products and services within the reporting period, by:</p> <ul style="list-style-type: none"> i. incidents of non-compliance with regulations resulting in a fine or penalty; ii. incidents of non-compliance with regulations resulting in a warning; iii. incidents of non-compliance with voluntary codes. <p>b. If the organization has not identified any non-compliance with regulations and / or voluntary codes, a brief statement of this fact is sufficient.</p>	Not Disclosed
-------	---	---	---------------

417: Marketing and Labeling

417-1	Requirements for product and service information and labeling	<p>a. Whether each of the following types of information is required by the organization's procedures for product and service information and labeling:</p> <ul style="list-style-type: none"> i. The sourcing of components of the product or service; ii. Content, particularly with regard to substances that might produce an environmental or social impact; iii. Safe use of the product or service; iv. Disposal of the product and environmental or social impacts; v. Other (explain). <p>b. Percentage of significant product or service categories covered by and assessed for compliance with such procedures.</p>	<ul style="list-style-type: none"> ➤ Society > Communicate with Stakeholders > Communicate with Our Customers ➤ Meiji Group Food Nutrition Labeling Policy
-------	---	---	--

401: Employment

417-2	Incidents of non-compliance concerning product and service information and labeling	<p>a. Total number of incidents of non-compliance with regulations and / or voluntary codes concerning product and service information and labeling, by:</p> <ul style="list-style-type: none">i. incidents of non-compliance with regulations resulting in a fine or penalty;ii. incidents of non-compliance with regulations resulting in a warning;iii. incidents of non-compliance with voluntary codes. <p>b. If the organization has not identified any non-compliance with regulations and / or voluntary codes, a brief statement of this fact is sufficient.</p>	Not Disclosed
417-3	Incidents of non-compliance concerning marketing communications	<p>a. Total number of incidents of non-compliance with regulations and / or voluntary codes concerning marketing communications, including advertising, promotion, and sponsorship, by:</p> <ul style="list-style-type: none">i. incidents of non-compliance with regulations resulting in a fine or penalty;ii. incidents of non-compliance with regulations resulting in a warning;iii. incidents of non-compliance with voluntary codes. <p>b. If the organization has not identified any non-compliance with regulations and / or voluntary codes, a brief statement of this fact is sufficient.</p>	Not Disclosed

418: Customer Privacy

--

401: Employment			
418-1	Substantiated complaints concerning breaches of customer privacy and losses of customer data	<p>a. Total number of substantiated complaints received concerning breaches of customer privacy, categorized by:</p> <ul style="list-style-type: none"> i. complaints received from outside parties and substantiated by the organization; ii. complaints from regulatory bodies. <p>b. Total number of identified leaks, thefts, or losses of customer data.</p> <p>c. If the organization has not identified any substantiated complaints, a brief statement of this fact is sufficient.</p>	Not Disclosed
419: Customer Privacy			
419-1	Non-compliance with laws and regulations in the social and economic area	<p>a. Significant fines and non-monetary sanctions for non-compliance with laws and / or regulations in the social and economic area in terms of:</p> <ul style="list-style-type: none"> i. total monetary value of significant fines; ii. total number of non-monetary sanctions; iii. cases brought through dispute resolution mechanisms. <p>b. If the organization has not identified any non-compliance with laws and / or regulations, a brief statement of this fact is sufficient.</p> <p>c. The context against which significant fines and non-monetary sanctions were incurred.</p>	Not Disclosed

Sustainability Accounting Standard Board (SASB) Reference Table

The Sustainability Accounting Standards Board (SASB) is an independent, standards-setting organization that promotes disclosure of material sustainability information to meet investor needs. This table below references the Standard for the Processed Foods industry as defined by SASB's Sustainable Industry Classification System (SICS) and identifies where Meiji Holdings addresses each topic.

Topic	Accounting Metric	SASB Code	Location	Notes
Energy Management	(1) Total energy consumed, (2) percentage grid electricity, (3) percentage renewable	FB-PF-130a.1	<ul style="list-style-type: none"> ➤ ESG Data > Environment > Climate Change > Energy consumption ➤ Integrated Report 2019 P15/60-61 : Financial and Non-Financial Highlights > Energy consumption volume ■ CDP 2019 	<p>We currently do not disclose (2) and (3); however, we use renewable energy at production plants and report the power generation volume.</p> <p>➤ Solar Power Generation at Meiji Production Plants</p>
Water Management	(1) Total water withdrawn, (2) total water consumed, percentage of each in regions with High or Extremely High Baseline Water Stress	FB-PF-140a.1	<ul style="list-style-type: none"> ➤ ESG Data > Environment > water > Total water used ➤ Integrated Report 2019 P43 : Water > Water Consumption Volume for FY2018 ➤ Integrated Report 2019 P15/60-61 : Financial and Non-Financial Highlights > Water consumption volume 	<p>We currently do not disclose the percentage. However, we assess the water risks in all areas where our domestic and international production sites are located in order to understand the impact of water usage on production.</p> <p>➤ Survey of Water Risks</p>
	Number of incidents of non-compliance associated with water quantity and/or quality permits, standards, and regulations	FB-PF-140a.2	Not disclosed	
	Description of water management risks and discussion of strategies and practices to mitigate those risks	FB-PF-140a.3	<ul style="list-style-type: none"> ➤ Water > Secure Water Resources > Appropriate Water Management and Water Risks ➤ Integrated Report 2019 P43 : Water 	
Food Safety	Global Food Safety Initiative (GFSI) audit (1) non-conformance rate and (2) associated corrective action rate for (a) major and (b) minor non-conformances	FB-PF-250a.1	No critical non-conformance found in FY2018	

Topic	Accounting Metric	SASB Code	Location	Notes
	Percentage of ingredients sourced from Tier 1 supplier facilities certified to a Global Food Safety Initiative (GFSI) recognized food safety certification program	FB-PF-250a.2	<ul style="list-style-type: none"> Quality and Safety > Ensure Product Quality and Safety 	We currently do not disclose the percentage of ingredients; however, we have obtained GFSI Certification for 50% (24 plants) of domestic food plants and 67% (4 plants) of overseas food plants.
	(1) Total number of notices of food safety violation received, (2) percentage corrected	FB-PF-250a.3	No food safety violation received in FY2018	
	(1) Number of recalls issued and (2) total amount of food product recalled	FB-PF-250a.4	No recall issued in FY2018	
Health & Nutrition	Revenue from products labeled and/or marketed to promote health and nutrition attributes	FB-PF-260a.1	<ul style="list-style-type: none"> Integrated Report 2019 P23 : Overview by Business Food Segment > Growth Strategy From FY2019 Integrated Report 2019 P63 : Overview by Business (Food Segment) > Nutrition Business 	
	Discussion of the process to identify and manage products and ingredients related to nutritional and health concerns among consumers	FB-PF-260a.2	<ul style="list-style-type: none"> Health and Nutrition 	
Product Labeling & Marketing	Percentage of advertising impressions (1) made on children and (2) made on children promoting products that meet dietary guidelines	FB-PF-270a.1	Not disclosed	
	Revenue from products labeled as (1) containing genetically modified organisms (GMOs) and (2) non-GMO	FB-PF-270a.2	Not disclosed	

Topic	Accounting Metric	SASB Code	Location	Notes
	Number of incidents of non-compliance with industry or regulatory labeling and/or marketing codes	FB-PF-270a.3	Not disclosed	
	Total amount of monetary losses as a result of legal proceedings associated with labeling and/or marketing practices	FB-PF-270a.4	Not disclosed	
Packaging Lifecycle Management	(1) Total weight of packaging, (2) percentage made from recycled and/or renewable materials, and (3) percentage that is recyclable, reusable, and/or compostable	FB-PF-410a.1	Not disclosed	
	Discussion of strategies to reduce the environmental impact of packaging throughout its lifecycle	FB-PF-410a.2	Circular Economy Integrated Report 2019 P43 : Circular Economy > Initiatives for Recycling Plastic Resources	
Environmental & Social Impacts of Ingredient Supply Chain	Percentage of food ingredients sourced that are certified to third-party environmental and/or social standards, and percentages by standard	FB-PF-430a.1	Sustainable Procurement	
	Suppliers' social and environmental responsibility audit (1) non-conformance rate and (2) associated corrective action rate for (a) major and (b) minor non-conformances	FB-PF-430a.2	Zero critical non-conformances found in FY2018	
Ingredient Sourcing	Percentage of food ingredients sourced from regions with High or Extremely High Baseline Water Stress	FB-PF-440a.1	Not disclosed	
	List of priority food ingredients and discussion of sourcing risks due to environmental and social considerations	FB-PF-440a.2	Sustainable Procurement	

Activity Metric	Code	Location
Weight of products sold	FB-PF-000.A	We do not publicly provide this proprietary information.
Number of production facilities	FB-PF-000.B	🔗 Integrated Report 2019 P104-105 : Operating Bases and Group Companies

External Recognition

We are open to working with ratings and rankings agencies suggestions to support continuous improvement.

SRI indexes and evaluations

(As of March 17, 2020)

Dow Jones Sustainability Asia Pacific Index (DJSI Asia Pacific)

Stock indexes developed jointly by U.S.-based S&P Dow Jones Indices and Switzerland-based RobecoSAM. The indexes analyze corporate activities based on economic, environmental, and social factors and select companies with outstanding sustainability performance. Meiji Holdings was selected for the first time as a component of the DJSI Asia Pacific indexes in 2019.



SNAM Sustainability Index

The SNAM sustainability index is a proprietary active index created by Sompo Japan Nipponkoa Asset Management which combines ESG (environment, social, and governance) and equity fundamental evaluation.

■ Sompo Japan Nipponkoa Asset Management



Evaluations

CDP

The UK-based international non-governmental organization promotes climate change and other initiatives in the area of the environment. The CDP requests disclosure of information on how leading companies and cities around the world are taking action on issues such as climate change and water management, and conducts surveys and evaluations. In 2019, Meiji Holdings received a high grade of A- in the area of climate change, scores of B- in the areas of water security, forests (timber), forests (palm oil), forests (soy), and a score of C in the area of forests (cattle).



Access to Nutrition Index™ (ATNI)

We were ranked 17th out of 22 global food and beverage manufactures in the 2018 Access to Nutrition Index™ (ATNI). The goal of the Access to Nutrition Indexes is to facilitate improved diets and a reduction of the serious global problems of both obesity and undernutrition.

■ Access to Nutrition Index™ (ATNI)



Outstanding Health and Productivity Management Organization (White 500)

Meiji was recognized jointly by the Ministry of Economy, Trade and Industry and the Nippon Kenko Kaigi in the Health and Productivity Management Organization Recognition Program in the large enterprise category (White 500) for practicing outstanding health and productivity management working together with insurers. Meiji has continued to be selected for this program since 2017.



Sustainability Announcements

2020

- Apr 1, 2020 2018-2019 Progress Report for Tackling Deforestation in Ghana
- Feb 14, 2020 We received a high grade of A- in CDP climate change
- Jan 7, 2020 We updated Standard Table

2019

- Dec 19, 2019 **【Presentation】** Sustainability Meeting ~ Meiji Group's Approach to Sustainability ~
- Dec 10, 2019 Endorsing the TCFD, Joining the TCFD Consortium
- Oct 31, 2019 Integrated Report 2019
- Oct 31, 2019 We updated sustainability web site
- Oct 3, 2019 Meiji Added to the Dow Jones Sustainability Asia Pacific Index
- Jul 31, 2019 We updated ESG Data
- Mar 29, 2019 Tackling Deforestation in our Cocoa Supply Chain
- Mar 27, 2019 Top Commitment to Sustainability

2018

- Nov 16, 2018 GRI Standard Table
- Oct 1, 2018 We updated sustainability web site
- Sep 14, 2018 Integrated Report 2018
- Aug 8, 2018 We updated ESG Data
- Jun 5, 2018 Notice of the 9th Ordinary General Meeting of Shareholders